

Digital Video Surveillance System

User Manual

- ※ The picture might differ according to the specification and model.
- ※ Contents of this user manual are protected under copyrights and computer program laws.

Edition : 20 Mar 2008 (GUI-2)

Thank You

Thank you for purchasing !
Before operating the system, please read this User Manual thoroughly and retain it for future reference.

WARNING

TO REDUCE FIRE OR SHOCK HAZARD,
DO NOT EXPOSE THE UNIT TO RAIN OR MOISTURE.

This installation should be made by a qualified service person
and conformed to all local codes.

Cautions

Read Before System Operation

Follow these details to prevent material damage or personal injury.

Signs of Caution and Warning



Warning: This sign indicates that the user could die or be seriously wounded if not used or installed properly.



Caution: This sign indicates that the user could be wounded or could expect property damage if not used or installed properly.



Warning: Do not expose the product to fog, rain or too much humid to decrease danger from electric shock or fire.

Important Safeguards



Warning

1. Change the battery after turning off the power of the product.
 2. Check the polarity of the lithium battery while changing.
 3. Change the battery with the same one, which is in the product or with the similar type recommended by your vendor.
 4. Dispose of the changed battery according to the instructions of the battery manufacturer.
- ※ There is danger of explosion when instructions are not followed.

General Warning



Warning

1. Use the power cord, which is supplied or recommended by the supplier, or it may cause fire.
2. Do not disassemble or reassemble the product.
It may cause malfunction or fire.
3. Enquire to your vendor for repair.
It may cause electric shock or fire if the repair is not done properly.
4. Do not touch the product with wet hands.
It may cause malfunction or electric shock.
5. Product installation must be ensured to a professional for product installation, or it may cause malfunction, electric shock or fire.
6. Ground applies to video products equipped with a 3-wire grounding type plug having a third (grounding) pin.
This plug only fits into a grounding-type power outlet.
If grounding is not done, it may cause malfunction or electric shock.
7. Ground connection must not touch gas pipe, water pipe or telephone line.
If grounding is not done properly, it may cause electric shock.
8. Prevent metallic foreign substance from going inside the product.
It may cause malfunction or electric shock.
9. Do not spray insecticide or flammable spray while driving.
It may cause fire.
10. Place the system in an open place where air ventilation is guaranteed, or it may cause over-heating and seriously damage the system to be fired.
11. Prevent water from instilling inside electrical parts.
Clean with a dry towel or malfunction or electric shock could result.



Caution

1. Use the power cord, which is supplied or recommended by the supplier.
The internal fan rotates at high speed and may cause an accident.
2. Do not drop, give strong vibration, or shock to the product.
It may cause malfunction.
3. The air inhler of the front panel and air outlet of the back panel must not be blocked during installation.
The internal temperature of the product would be greater than allowable and could cause malfunction or fire.
4. Do not touch the product or the power cord when there is thunder.
It may cause electric shock.
5. Do not install the product near or on top of heating source.
The internal temperature of the product would be greater than allowable and could cause malfunction or fire.
6. Do not install the product on inclined or unstable location or where vibration could be committed.
It may cause malfunction.

Cautions about the Power



Warning

1. Must use the outlet of the grounding to connect the power cord, or it may cause fire.
2. Do not connect on the middle of power cord or use extension cord.
It may generate heat or cause fire.
3. Do not touch the power cord with wet hands.
It may cause electric shock.
4. Keep power cord dry and protect from humidity.
It may generate heat or cause fire. The power cord is not waterproof.
5. Hold the body of the plug while removing the power plug.
Do not pull the power cord. Damage to the power cord may generate heat or cause fire.
6. Check the power plug regularly.
Humidity and moderation in smoking may cause fire.
7. Remove power cord from outlet when product is not used for a long time.
It may cause short-circuit or electric shock.



Caution

1. Do not turn off the power by removal of the power plug.
To turn off the power, click the power button from the front panel.
When the system stops abnormally, the power button might not work. Click power button for 5 full seconds to turn power off.
2. Do not cut off the power artificially, or give shock or vibration to unit while the hard disk is activating.
It may cause hard disk failure or loss of data.



Remarks

- ※ Pictures and buttons are subject to be changed or modified up to different models.

Contents

1.	GETTING STARTED	1
1.1	CHECKING SUPPLIED ITEMS.....	1
1.2	CONNECTING PERIPHERAL DEVICE	2
1.3	SYSTEM STARTUP AND SHUTDOWN.....	3
2.	EXPLANATION FOR EACH FUNCTION	5
2.1	FRONT PANEL.....	5
2.2	REAR PANEL.....	5
2.3	IR REMOTE CONTROLLER	5
3.	OPERATION.....	6
3.1	USER LOG-IN.....	6
3.2	LIVE MODE.....	7
3.3	PTZ OPERATION.....	10
3.4	PLAYBACK RECORDING IMAGES.....	12
3.5	QUICK BACKUP DURING PLAYBACK	13
3.6	SEARCH RECORDING IMAGE	14
4.	SETTING	18
4.1	SYSTEM.....	19
4.2	DEVICE.....	26
4.3	RECORD.....	31
4.4	NETWORK	35
4.5	BACKUP.....	42
4.6	QUICK SETUP	46
4.7	WEB SURVEILLANCE	47
5.	SPECIFICATION	51

1. Getting Started

1.1 Checking supplied items

Make sure that you have following items supplied with your DVR. Keep the packing utilities for moving or storage purposes afterwards.

Note If any of these items is missing or damaged, notify your vendor immediately.

Items	Photo	Quantity
User Manual & CD Rubber Mount	 	1 Set 1 Set (4 Pieces)
12V Adaptor & Power Cable		1 Set
IR remote Controller & AAA Battery		1 Set
Terminal Block (External)	  <p data-bbox="595 1290 762 1313">[4 & 8 Ch Model]</p> <p data-bbox="793 1290 927 1313">[16 Ch Model]</p>	1 Pair (2 Pieces)
<p data-bbox="257 1373 450 1406">[Optional Item]</p> <p data-bbox="248 1437 403 1522">Loop-Out Board with Cable & Hexagonal Rod</p> <p data-bbox="248 1611 444 1634">External BNC Cable</p> <p data-bbox="248 1673 495 1727">※ In case of 16 Ch, you need 2 sets of 8 Ch loop board.</p>	 	1 Set (For 8 Ch) 1 Set (For 8 Ch)

1.2 Connecting Peripheral Device

This section describes how to efficiently hook up peripheral devices with the DVR.

Install the DVR on flat surface. If required, attach a rubber mount for installation. In case that 19-inch rack is used, it is recommend to install the system on shelf and use 2.5~3U (1U=1.75 inch or 4.45 cm) space for proper ventilation.

Note Install the system in location with good ventilation to prevent overheating.

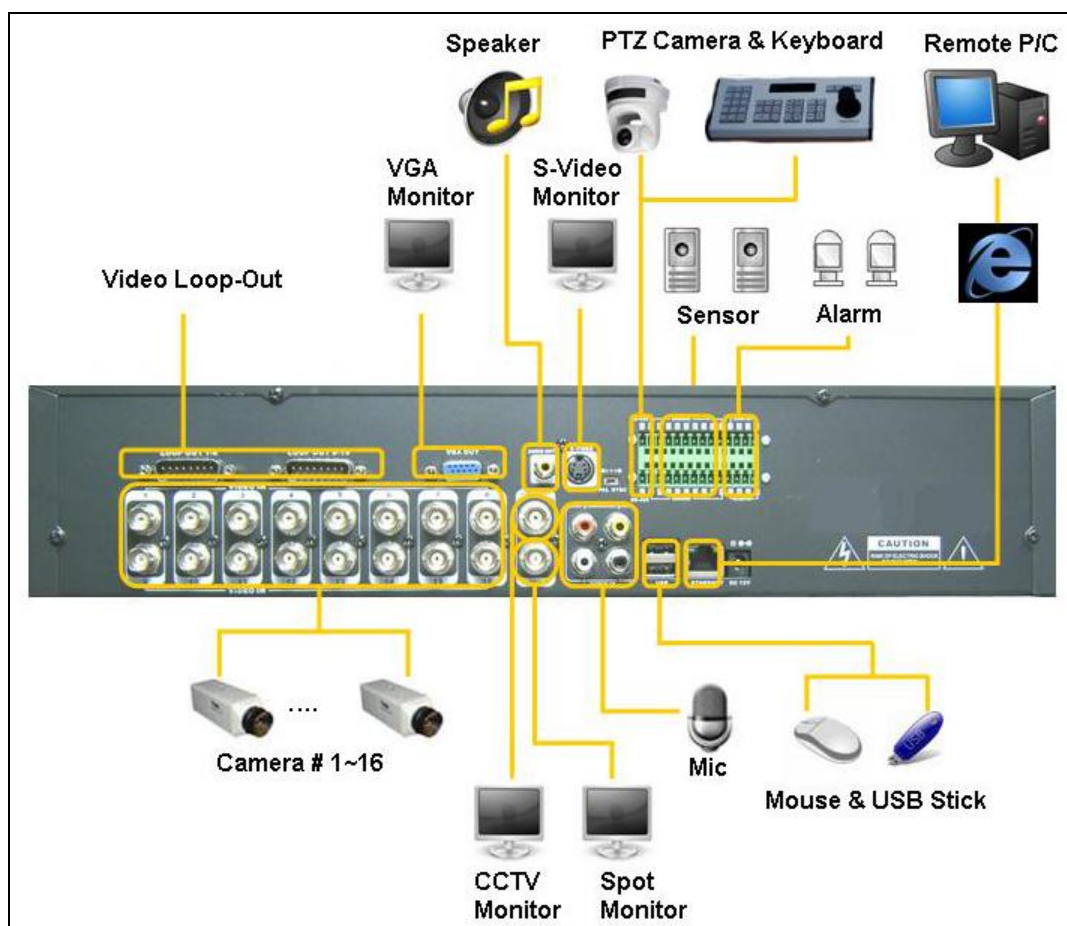

Caution

- ※ The layout of the rear panel on the DVR might differ according to the models.
- ※ Depending on the grounding, the coaxial cable connecting to the camera has danger of electric shock. Shut down power of the system completely (unplug the power cable) before connecting video cable to BNC port.

1.3 System Startup and Shutdown

1.3.1. System Startup

After connecting all peripheral devices, connect power cord to the DVR for system startup.

Log in "admin password" after switching on power button. This is to prevent others from using.

The factory default password is "1234".

"Admin" user is to fully control the entire DVR system.

User can log in by other user's name if he/she adds new user setting in menu.



Note Do not forget the administrator's password that was set for the first time. In case the password is lost, enquire to your vendor.

Note For the use of wired-USB mouse, it is highly recommended for user to have well-known major brands such as DELL, MICROSOFT, LOGITECH or SAMSUNG.

Note It may take a few minutes to start working the system right after turning on in the case that user leaves the network configuration in DHCP and at the same time there is neither DHCP server in user's network, nor physical network connection.

1.3.2. System Shutdown

To turn the power off, Click “MENU” button and then click “SHUTDOWN” in the GUI S/W as below picture.
Do not pull off the power by pulling the power plug.

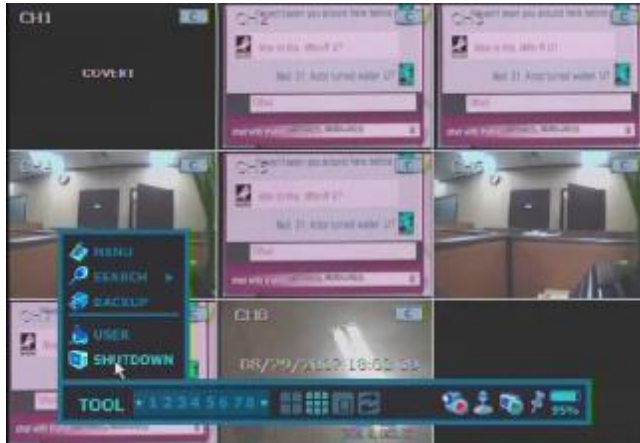

The factory default password is 4 digits of “1234” as below picture.



Note User can input password by virtual keyboard, or front numeric buttons (if available).

2. Explanation for Each Function

2.1 Front Panel

2.2 Rear Panel

2.3 IR Remote Controller

Please refer to a separate-volume

3. Operation

3.1 User Log-in

Check the power connection. The system can be used after power-on.

The DVR has various setting categories. The administrator can set the system password and <User> to prevent unauthorized changes to setting values and alteration to recorded file.

Enter the <Admin> or <User> password which had been set. In case the <Admin> and <User> passwords are same, it will recognize as <Admin>.



Note <LOG-IN> window will be permanently displayed in monitor as above picture until user logs in with the right ID & password.

3.2 Live Mode

3.2.1. Channel selection

Real-time live image can be seen by easy button operation after powering on.

The images can be seen real-time by 1, 4, 9, 16 and PIP screen. Whenever the up/down arrow button on the front panel or IR remote controller is pressed, the screen will be sequentially changed. To change the channel from 1 screen mode, press the left/right arrow button on the front panel or IR remote controller.

















To select channel by mouse, make double click of the left mouse button. To return previous screen mode after selecting certain full channel, make another double click of the left mouse button.

Note To properly select channel by mouse, user is supposed to make slow and clear double-click of the left mouse button.

3.2.2. Icons

In real time live mode, icons or messages will be indicated on the screen to notify the system mode or status.

Below are the icon categories, which are indicated on the monitor.

Icon to be shown at right-upper corner on each channel screen		Icon to be shown at right-bottom corner on full screen.	
	Continuous Recording		No HDD, Smart Alarm & HDD Failure
	Motion Detection Recording		Using Emergency Recording
	Sensor Activating Recording		Using PTZ
	Continuous + Motion Alarm Recording		Warning for exceeding temperature
	Continuous + Sensor Activating Recording		
	Motion Detection + Sensor Activating Recording		
	Emergency Recording		
	Sensor Activated		
	Motion Detected		
	Audio Channel		
	PTZ Camera		

User can place USB mouse pointer in the bottom of the monitor in live mode. Then menu bar will be instantly appeared as below picture.



Cross icon button  means "instant (emergency) recording", which is useful to urgently start recording. In emergency recording, the system maximizes the full recording frames to allocate it to all the channels available equally at 1CIF resolution.

Dome camera icon button  means "PTZ" mode, which is useful to instantly switch to PTZ control. In PTZ mode, user can move pan/tilt and zooming-in/out by moving the mouse pointer, called virtual joystick.

User can click the right-forwarded arrow button  to automatically playback the latest video clip.

Pin icon button  means that user can fix this menu bar, or disable fixing the menu bar by moving out mouse pointer. If user fixes the menu bar, then this menu will not disappear even though user moves away mouse pointer out of this range. If user does not fix the menu bar, then the menu will be shown when user places mouse pointer in this bottom area only.

Circle icon button  means the HDD usage percentage by video recording. If it shows 60%, then 60% of HDD space has been used up for recording.

Note If you can not find any colored-mark in the right up corner of the live screen mode, then it means that the system does not record any image. In this case, you need to check recordings schedule or camera of the main setup menu.

User can click the right button of the mouse to pop up sub-menu as below picture.



To select channel by mouse, make double click of the left mouse button. To return previous screen mode after selecting certain full channel, make another double click of the left mouse button.

3.3 PTZ operation

User can get into PTZ mode by clicking right button of mouse and selecting "PTZ" in the pop-up menu as below, or select joy-stick button () in the menu bar appeared in the bottom of the main screen.



In PTZ mode, user can control PTZ operation with USB mouse.

While pressing the left button of mouse, user can drag the mouse pointer to up/down or left/rightward to move pan/tilt position of the camera. If user moves the mouse pointer long away from the center position of the main screen, the PTZ camera moves at faster speed.

User can also move zoom-in/out by rolling the wheel of mouse to up or downward.



Note Full PTZ functions are valid by only USB mouse, IR remote control, or keyboard controller.
User can only control pan & tilt functions by front key buttons.

For focus control in PTZ screen mode, user can click right button of mouse again to get the pop-up menu as below picture.

Default mode is to tick "ZOOM". Thus, user can tick "FOCUS" to switch the wheel function of mouse from zoom-in/out to focus. Then, user can control focus by moving the wheel of mouse.

In the same way, user can select preset button or exit PTZ screen mode.



Note User will see numeric pad to select "Preset" number, once after user set a PTZ protocol in setting menu. Maximum Preset number is 255.

3.4 Playback Recording Images

To playback recorded image, press Play button from the Front Panel or IR Remote Controller. Press the Play button and the latest recording image will be playback.

It is easy to use USB mouse or the Front Panel's Jog/Shuttle to playback recording files. Turn the Jog and the recorded files can be seen backwards or forwards. Turn the Shuttle and the playback speed can be controlled 2, 4, 8, 16, 32 times while playback backwards or forwards.

User can click the right-forwarded arrow button  to automatically playback the latest video clip.



The below picture is when the system plays back video.

In playback screen, user can make various playback modes, make an instant manual backup/archive), go to calendar search mode, change channel, and change screen modes. User can make a click of the left mouse button in colored-time bar to move white-vertical line that represents playback time.



3.5 Quick backup during playback

User can easily archive video while he/she watches video playback.

In playback mode, user can press “ENTER” button in the front panel to set archive “start” time.

After pressing this “ENTER” button, user will see “Quick backup starts” in right bottom of the playback monitor.

Once “Quick backup starts” message is shown, user can keep playing back video until user wants to finish archiving, and then press the same “ENTER” button again to set backup “end” time. Then backup menu window will be popped up upon pressing “ENTER” button, which has set backup “start” time, “end” time, and the backup video channels to be archived. In this menu window, user can select the backup media like CD/DVD or USB thumb drive, and execute archiving.



Press “ENTER” button to set “start” & “end” time of archive during video playback.



3.6 Search Recording Image

3.6.1. Calendar Search

The user can select date and time to search for a certain file within the recorded image.



User can move right & left the white-vertical line to the time that user wants to search.

The colors of the time bar are different by each recording mode. Please, refer to section 4.3.2 for details on colors. Time bars in color shows by 4channel group.

Black bold in date as above picture means that there is a video data recorded.

3.6.2. Search Date/ Time

Enter the desired date and time for the user to playback the recorded image.

Use the arrow button to move to each day/month/year and time category for selecting second/minute/hour/month/year.



3.6.3. Event Log

The Event log search is used to find particular event, quickly and easily.

User can copy this even list to built-in CD/DVD burner or USB memory device in text file format.

Once CD/DVD media is inserted or USB memory stick is put via USB port, user must press "SCAN" button to detect it, and then press "EXPORT" to copy the log information to the media.



To see particular event of activated time, move the arrow button of the Front Panel or Remote Controller to the desired time range.

Following is the category indicated on the Event Viewer.

1. Alarm by Sensor
2. Alarm by Motion
3. Alarm by Video Loss

Note In case the Alarm does not activate even though the alarm input setting had been done, check the alarm connection port of the product's rear panel.

3.6.4. System Log

The system log search is used to find particular system log information, quickly and easily. User can copy this event list to built-in CD/DVD burner or USB memory device in text file format.



Once export is completed, user can find a date folder created in backup media like CD/DVD or USB thumb drive. There is "system.log" file stored in the date folder.

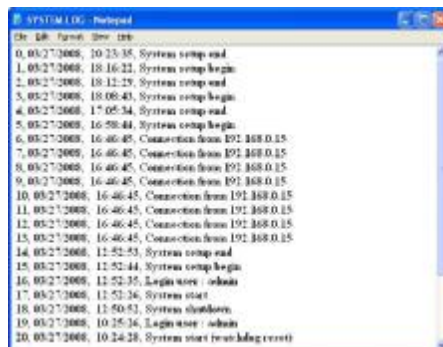

Following is the category indicated on the system log viewer.

1. Log by system
2. Log by setup
3. Log by network

Note 20 numbers of log record will be shown on one page of the <System Log> and <Event Log> window. User can click the arrow icon to search the log records on another page.



3.6.5. First Data

Go to the first screen of the recorded image. This is the oldest image recorded.

3.6.6. Last Data

Go to the last screen of the recorded image. This is the latest image recorded.

4. Setting

General setting structure consists of "System", "Device", "Record", "Network", "Backup" and 'Quick Setup" as below.

Main Classification	Sub Classification
SYSTEM	SYSTEM INFO
	USER
	EXPORT/IMPORT
	HDD
	FACTORY DEFAULT
DEVICE	CAMERA
	AUDIO
	SENSOR
	MOTION ALARM
	EXTRA ALARM
RECORD	PTZ
	CAMERA
	SCHEDULE
NETWORK	NETWORK
	DDNS
	NOTIFICATION
BACKUP	MANUAL BACKUP
QUICK SETUP	QUICK SETUP

4.1 System

User can find the menu button in "TOOL" of the menu bar or pop-up menu of mouse right button.

User can move mouse pointer from "System" through "Quick Setup" to instantly look around the sub-menus in the large egg.

Upon clicking mouse left button, user can fix the menu category that he/she wants to get into.



4.1.1. System Info.

This is used to check system information status or change the system-related configuration.

User can move to other sub-menu of the System; System Info, User, Export/Import, HDD, and Factory Default by moving mouse pointer or pressing the front arrow buttons.

Mac address is the unique identity number for each system, and a must to use dynamic IP connection.

NTSC/PAL is convertible by moving pin switch on rear panel of the system and rebooting.



User can name site by using virtual keyboard as below ;



In "DATE/TIME SET", user can activate DST(Daylight saving time), and select time synchronization server, besides of basic settings like time zone/time format.



Note Video images might be heavily shaking and blinking in probably black & white if NTSC/PAL is not properly set. User needs to make sure of NTSC/PAL setting fit to electric standard of user's location.

Note There are two types of TIME SYNC MODE.

1) Server Mode

The operating DVR is set as a Time Sync Server, which can synchronize the time clock of another DVR(s) connected over same network environment.

2) Client Mode

The operating DVR is set as one of the client DVR(s). Input the IP No of designated DVR or RemoteManger P/C as a Time Sync Server in "SYNC SERVER", then its time clock is synchronized with Time Sync Server by setup time in "SYNC CYCLE".

User can easily upgrade the system in "Upgrade Firmware" menu via DVD/CD/USB/FTP server upon his/her selection as below ;



Procedure **How to upgrade system firmware by using USB memory stick**

- 1) Put USB thumb-drive in any USB port of DVR that shall be compatible with USB 2.0 version
 - 2) Once the system detects the thumb-drive, user can see a brand or model name of it in "DEVICE" after pressing "SCAN" button.
 - 3) Click "SCAN" button to get DVR recognize it, and click "OK" to confirm archiving.
-

Caution It is recommended to proceed "HDD Format" after finishing the upgrade of firmware, because the data recorded by previous firmware may cause mal-function of DVR due to different format.

In "Display Setting", user can set sequence dwell time, spot-out dwell time, the spot-out channel, and OSD as below picture.

User can set spot-out & sequence dwell time in this menu as well as OSD show/no-show. Alpha blending is the transparency level of the menu screen. 100% means no transparency at all.



Note This system supports a variety of video resolutions ; 640x480, 800x600, 1024x768 and 1280x1024. User needs to set the proper resolution in accordance with the monitor resolution.

4.1.2. User

Master user of this system is always Admin with factory default password of "1234" for full functionality.

Admin can change the password in this category.

Admin can designate a new user to different permission levels by ; functions, menu access, and live & playback.

"FUNCTION" is to restrict a user to control a certain function like shutdown, search, PTZ control, backup and playback.

"MENU ACCESS" is to restrict a user to access a certain main menu setting like system, device, record, network, backup, and quick setup.

"LIVE & PLAYBACK" is to restrict a user to see both live display and playback video for a certain camera channel.



Note Total number of users including administrator is 32 people.

4.1.3. Export/Import

User can copy and paste the system configuration values in this menu.

"Export" means when user want to copy the setting values of this system to USB memory devices.

"Import" means when user want to call up the setting values of other system from CD/DVD/USB memory devices. During import process, make sure that the FW version of source DVR has to be same as the one of target DVR which user wants to import setting values to.



4.1.4. HDD

HDD information is shown in this menu.

User can select “Overwrite” or “Stop recording” when HDD becomes full.

User also can easily format new HDD or existing HDD.

The number of maximum built-in HDD units is dependent on models.



Note It takes around 2minutes for 250GB, 3minutes for 500GB, or 4minutes for 750GB each.

Note The system always reserves maximum 5GB space in each built-in HDD to effectively utilize archiving memory.

Note Primary Master HDD must be no larger than 500GB during format, while other slave HDD(s) are limitless in capacity each.
If user wants to install a big-capacity HDD (over 500GB) at primary master HDD position, user has to install both a small-capacity HDD (lower than 500GB) at primary master position and a big one at slave position and proceed the format for both HDD(s). Once the format is completed, user can replace primary master HDD (lower than 500GB) with slave HDD (over 500GB), consequently to have a big-capacity HDD (over 500GB) at primary master position.

Note User has to format primary master HDD (1st HDD) first before formatting over-500GB HDD in other slave positions, because the system has to utilize the primary master HDD as a virtual memory to format such a high-capacity of HDD over 500GB size in slave position.

To achieve high-level system stability, warning message as below will be popped up when temperature inside the system exceeds optimum range. This problem may be driven from mal-function of ventilation fans. In this case, user shall inspect if the cooling fan is properly working, or ambient temperature around the system is properly kept.

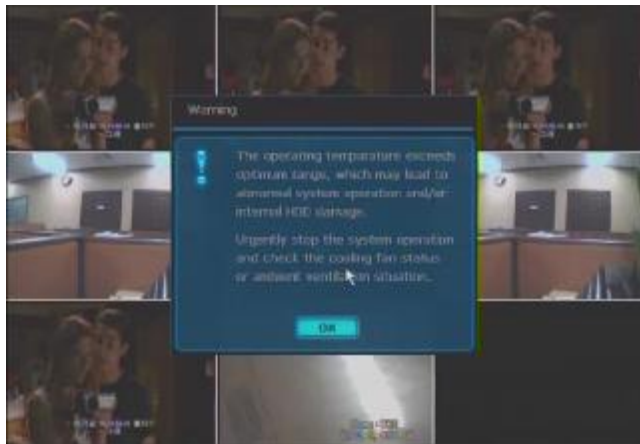

4.1.5. Factory Default

With authorized password, user can get the system back to factory default configuration.



Note Upon clicking "OK" button, all the configuration values made by user will be deleted. The system setting will be originated by factory defaults. However, video data recorded are protected.

4.2 Device

4.2.1. Camera

User can easily move to “Device” menu by selecting the icon  in right up side of the menu screen. “Covert” is to hide camera display and playback as if there is no camera recording, so called “hidden camera” feature.

Default motion area setup is to select entire camera area.



4.2.2. Audio

User can select 4 audio input on & off, and match the audio input to a designated channel in next Setting [RECORD > Camera > Audio].



Note Audio is to record and stream over network, that is, user can not listen to any audio in live display mode but listen to the audio in playback mode at DVR. However, user can listen to the audio in both live display and VOD mode through network by RemoteManager S/W and/or IE web browser.

4.2.3. Sensor

“Intensive” means that the system increases recording speed up to the maximum frame at the selected resolution upon alarm triggered during the selected dwell time. The recording speed of all other channel will be automatically decreased during alarm-triggered intensive recording, and also will trigger alarm signal via the selected sensor-out channel.



§ **ON/OFF**

Turn on or turn off the sensor

§ **CAM**

Select the associated camera

§ **OUT**

Select the associated alarm output

§ **INTENSIVE**

“Intensive” means that the system increases recording speed up to the maximum frame at the selected resolution upon alarm triggered during the selected dwell time. The recording speed of all other channel will be automatically decreased during alarm-triggered intensive recording, and also will trigger alarm signal via the selected sensor-out channel.

§ **DWELL (Post Alarm)**

Set the recording period from the start of sensor input activation. During this period, the corresponding camera image will record according to the frame and alarm (relay) output set. The recording stops and alarm output is turned off when the setting period is elapsed.

§ **PRE-ALARM**

Set recording period in seconds just before perceiving sensor input to up 3 seconds of time length.

The system records in certain seconds of time prior to the time that alarm is activated, so that user can search video even before alarm is triggered. The pre-alarm recording mode is always “continuous” at the recording speed that user sets in “record” of “camera” menu.

§ **TYPE**

Select the sensor type between N/O(Normal Open) and N/C(Normal Close), connecting to alarm input plate. Circuit of N/O type is usually open, and the activation of the sensor occurs at the time of close, and N/C type works the reverse way.

§ PRESET

User can select the camera to move to preset position, once the sensor is triggered. (User should setup preset position in PTZ menu 4.2.6 in advance)

§ NOTIFY

User can select how to be alerted upon sensor is activated or motion is triggered by pressing “NOTIFY” button. The system will generate buzzer sound in the selection of buzzer, or make pop-up screen of the camera in the selection of camera pop-up

Note “Sensor” here means the alarm connected to DVR, which is triggered by physical sensor input.



Note Check the setting of the sensor type (N/O or N/C), if the sensor does not operate properly. The alarm might not function if the actual connecting sensor type and the sensor type in the system setting are inconsistent.

Note “Camera pop-up” means that multi-screen live video mode will be switched to single channel mode automatically upon alarm triggered. This single channel video is the channel triggered by alarm.

4.2.4. Motion Alarm

Motion alarm is to record only when motion detection is triggered by DVR S/W upon user's motion area setting. The system records at maximum recording speed upon motion detection if user sets "on" in "Intensive" during selected dwell time and pre-alarm, and also will trigger alarm signal via the selected sensor-out channel.



Note "Motion Alarm" here means alarm triggered by motion detection set by motion menu of DVR.

4.2.5. Extra Alarm

S.M.A.R.T. alarm is to trigger alarm signal when HDD might be about to be out of operation. This alarm is created by HDD and captured by DVR. If HDD does not create this alarm, then DVR also does not capture and output and signal either.



4.2.6. PTZ



Protocol

Set the protocol to control the P/T/Z controller connected to P/T/Z port on the back panel. P/T/Z controller is also called receiver or RX if it becomes separated from camera. Set the controller address correctly for each channel after setting the protocol.

Address

Set the P/T/Z driver address of the connected camera.

Check the below items for proper P/T/Z operation.

1. Check if the protocol of all P/T/Z controllers connected to the system is in accordance.
2. Check if the communication setting including baud rate of all P/T/Z controllers is in accordance with the assigned value for that P/T/Z protocol.
3. Check if the address of all controllers is in accordance with the controller address assigned in the setting menu for that channel.
4. Check if the power of the P/T/Z controller is turned on.
5. Check if wiring to P/T/Z controllers is correct.

Procedure How to setup PTZ camera with Pelco-D protocol

- 1) Make sure of serial communication with the PTZ camera
 - 2) Select "Pelco-D" in the protocol list, and set address.
 - 3) Click "Save" button to confirm this configuration.
-

Preset

The system supports the number of preset from 1 to 255.

Baud rate

User can select the baud rate level from 2,400bps up to 57,600bps.

4.3 Record

4.3.1. Camera

“On/Off” is to switch “recording” on and off in each channel. If recording is not required on the selected channels, even when the camera signal is inputted, set the recording of the corresponding channel as [OFF]. Then, recording of the channel stops without pulling camera BNC cable off. [ON] or [OFF] can be selected. The default is [ON].

FPS means “Frame” consisting even and odd fields in each frame. Maximum recording FPS in total is 200fps(PAL)/240fps(NTSC). The system automatically calculates “Remained FPS”.

Select resolution for the recording image. In here, the resolution means required horizontal and vertical pixel number of a page. The resolution is indicated as (horizontal) X (vertical) pixel number. Thus, select one setting from 352×240, 720×240, 720×480. Default is 352×240. As the resolution number increases, the picture quality is higher. In fact, 352×240 is VHS level and when high quality camera is used, 720×480 show DVD level picture quality. When the picture quality gets higher, the storage capacity is bigger and the recording period will be shorter. Thus, selecting appropriate resolution according to the situation is important.

The setting value of “Quality” directly influences the byte size per image. For example, the byte size decreases as quality goes lower. In this case, blocking (mosaic) phenomena tends to appear, which is resulted by high compression. In contrast, blocking phenomena disappears as quality goes higher. In this case, the required storage space per image increases, which leads to shortening of total recording period. Therefore, give consideration to the necessary recording period, importance of each camera image, and quality of analog signal when setting the recording quality.

“Auto Del”, in full name of auto deleting, means that the system will overwrite video whatever is recorded longer than the number of days set by “Auto Del” in accordance with privacy regulation in certain country.

“Audio” Ch# 1 to 4 can be selected for each video channel.



Note “Auto Del” does not guarantee the number of recording days user set. For example, even though user sets 10days in “Auto Del”, if HDD space is not enough, then the system can not record up to 10days. This feature is not to keep video data for a certain number of days set by user.

If user sets 10days in “Auto Del” on August 20 for the system that has, for example, 30days of video data, then the system will keep video from August 11 to August 20 for 10days. All other video recorded before August 11 will be overwritten by the system. On August 21, the system will keep video from August 12 to August 21 for 10days.

Note The storage capacity for the same image will be different. Image per byte is ratio to the image dimensions (horizontal x vertical), thus 720×240(2CIF) is twice the size of 352×240(1CIF) and 720×480(D1) takes about 4 times the storage capacity. Therefore when high resolution is selected for the same period, the storage capacity taken up will be larger and the storage period will be shorter on the same Hard disk capacity.

Note The system usually have maximum operational burden in work-load for highest picture quality setting. Thus, the maximum recording speed up to 200fps(PAL)/240fps(NTSC) might not be guaranteed in highest picture quality mode, which means there might be some frame skipping phenomenon sporadically.

Note For the same resolution, frame per byte size will vary according to various reasons such as recording picture quality setting, movement, complexity of the image and noise. Therefore, total recording period will differ hugely according to the image particularity.

§ 352×240 : Standard Quality Standard 1~5KB

§ 720×240 : Standard Quality Standard 5~10KB

§ 720×480 : Standard Quality Standard 10~20KB

“Quality” by 40(low), 60(standard), 80(high), and 100(highest) makes frame size different by around 30% in each level.

4.3.2. Schedule

Set recording schedule for each camera. First, select the camera to set schedule, or "All". Recording can be set by each hour from 00 through 23 a day.

- No color** - Off
"Off" means no recording. Even though user set recording frames and on in "CAMERA", the system will not record anything if user sets "OFF" in SCHEDULE.
- Yellow color** - Continuous recording
In continuous recording mode, the system records all the time as set by "CAMERA".
- Green color** - Motion-detection recording
In this mode, the system records only when motion is detected in the motion area, and stops recording when motion is not occurred.
In addition, user can make motion recording configuration in "MOTION ALARM" of "DEVICE" menu. If user sets "OFF" in "MOTION ALARM" of "DEVICE" and sets "MOTION" in "SCHEDULE", then the system will not record anything even though motion is detected in motion area.
- Orange color** - Sensor-activated recording
In sensor mode, the system will record when sensor is triggered only during dwell time as set in "SENSOR" of "DEVICE" menu.
If user sets "OFF" in "SENSOR" of "DEVICE" and sets "SENSOR" in "SCHEDULE", then the system will not record anything even though a sensor is triggered.
- Sky Blue color** - "Continuous" + "Motion detection" recording
The system records all the time by "continuous" as set by "CAMERA" of "RECORD" but will switch recording mode to motion configuration as made by "MOTION ALARM" of "DEVICE" if motion is detected. in motion area. The system also will notify "motion event" message to Remote Manager PC over the network.
If user sets "OFF" in "MOTION ALARM" of "DEVICE" and sets "CONT + MOT" in "SCHEDULE", then the system will not record anything even though motion is detected in motion area.
- Dark orange color** - "Continuous" + "Sensor-activated" recording
The system records all the time by "continuous" as set by "CAMERA" of "RECORD" but will switch recording mode to sensor configuration as made by "SENSOR" of "DEVICE" if a sensor is triggered during dwell time. The system also will notify "sensor event" message to Remote Manager PC over the network.
If user sets "OFF" in "SENSOR" of "DEVICE" and sets "CONT + SENS" in "SCHEDULE", then the system will not record anything even though a sensor is triggered.
- Pink color** - "Motion detection" + "Sensor-activated" recording
The system does not record in normal operation but records only when motion is detected as set by "MOTION" of "DEVICE" and a sensor is triggered as set by "SENSOR" of "DEVICE".

If user set "OFF" in both "MOTION" of "DEVICE" and "SENSOR" of "DEVICE", then the system will not both record and notify to Remote Manager PC.

Caution **Black Color Bar**

File structure has been changed from F/W Version v2.2.0. Hence, when user searches for the data recorded under F/W Version v2.1.13 and before (after upgrading F/W to v2.2.0 at the system on operation), the system will show "Black Color Bar" when the searched data exists. However, the data recorded under F/W Version v2.2.0 and after will show normal color bar.



Note In case the recording schedule is set by “CONT + MOT” or “MOT + SENS”, then the system records by continuous or motion detection mode in normal operation. However, when motion is occurred in motion area or alarm is activated, then recording mode will be automatically switched to intensive recording as set by “MOTION” or “SENSOR” of “DEVICE” menu.

User can add holiday in HOLIDAY SETUP as below picture to up 32 holidays.
Press “DATE” first and write description, and then press “ADD” button to list up holiday.



Note Instant Recording (Emergency Recording)

In case of a specific model that has “Instant recording” button in front face, the system will instantly start recording all the channels at CIF resolution up to maximum 200fps in total when user press the “Instant recording” button. All the channels, regardless of recording mode & recording on/off, are to be recorded.

Red-colored bar is shown in the time search bar of playback mode for the video recorded by Instant(Emergency) recording. **E-REC** is shown in live mode when the system records by Instant(Emergency) recording mode.

4.4 Network

4.4.1. Network

The system has built-in web server.

Network type

Select network connect type. Select either LAN for fixed IP or DHCP for dynamic IP.

Gateway

This is the IP address of the network router or gateway server. It is required when the user wants to connect through the external router from the remote.



Note The system transfers video images at real-time speed over the network even during no record. For example, user can monitor live video even when motion is not occurred at motion detection mode.

Note The maximum number of simultaneous connection is 5 times the number of DVR channel, which means 20channel connections for 4channel model, 40channel connections for 8channel model, and 80channel connections for 16channel model.

For example, 5 people can connect to 16channel model DVR at the same time watching all 16 cameras each people, or 80 people can connect to 16channel model DVR at the same time watching only a specific single camera each people.

4.4.2. DDNS

DDNS is to use Dynamic IP server that is operated by manufacturer.
User has to tick on “Use DDNS” check-box to use it.

DDNS server

“cctv-link.net” is the fixed domain name of DDNS server operated by manufacturer.
User is not supposed to change this name.

TCP/IP Port

Factory default value of TCP/IP port is “10000”. **User can not change this port number.**



Note The standard DDNS domain name is cctv-link.net.
User has to select DHCP in “Network” after saving DDNS.

4.4.3. How to set DDNS

The setting in DVR

As shown below, user can just leave the DDNS setting in factory default.

DDNS server is cctv-link.net (218.38.55.151) that is the IP address of DDNS server at IDC.

User can leave the web port at 80, and press "SAVE" button.

After pressing "SAVE" button, user has to select "DHCP" in "NETWORK" and then start rebooting the system.



The setting in RemoteManager S/W

In "Setting" of "Option" menu of the RemoteManager S/W, user needs to make sure of the right DDNS IP and port. DDNS is "cctv-link.net" and Port is 80, which shall be same as the DDNS setting of DVR.

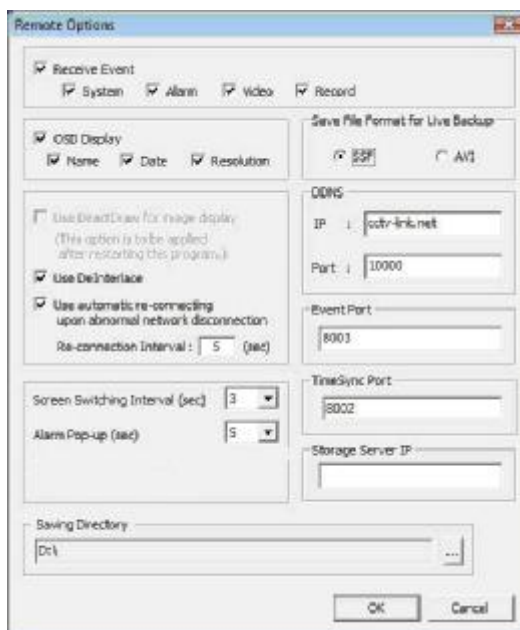

In "Registration" of "File" of the RemoteManager S/W, user can press "ADD" to go to "Site Property" as shown below. It is very important to put "Mac address + cctv-link.net" in IP Address(or URL) as below. User can find the right Mac Address of the system in "System Info" of "System" of the DVR. The web port shall be 80.

For example, if Mac address is "00:1C:84:01:00:02", then the right IP Address(or URL) in Site Property of the RemoteManager S/W shall be "001c84010002.cctv-link.net".

"cctv-link.net" is manufacturer's own DDNS server domain name.

System	
Name	Jdms 233
IP Address(or URL)	001c8401001e.cctv-link.n
Port	9010
Web Port	10000
Channel	1-16

- Input a channel number or range with comma.
ex) 1-4,6,11,12-16

Ok Cancel

The setting in Web browser

User can just type the mac address + cctv-link.net, for example, <http://00231c381f2d.cctv-link.net>.



The setting in Router

If user's network is by router, then user needs open the related-network ports in reference of below chart.

TCP Port List

Protocol	Port	Usage	Remark	Editable	Location
TCP	9010	Control port of authorization service	TCP Base Port	Yes	Network/ Network
TCP	9011	Control port of VOD service	TCP Base Port +1		
TCP	9012	Data port of VOD service	TCP Base Port +2		
TCP	9013	Control port of Live service	TCP Base Port +3		
TCP	9014	Data port of Live service	TCP Base Port +4		
TCP	9017	System log service	TCP Base Port +7		
TCP	8002	DVR system time sync service		Yes	System Info & Date/Time Setting
TCP	8003	Event notify socket (requesting port)		Yes	Network/ Notification
TCP	80	Web service		Yes	Network/ Network
TCP	10000	DDNS Server	Fixed		Network/ DDNS

4.4.4. Notification

Remote Notify

The system can notify an alarm message to the IP address of Remote Manager PC over the network.

User can choose various different kinds of alarms by pressing “ADD” for such as Log-in/Out, System start, Sensor, Video loss, Recording failure, Setup, Shutdown, Motion alarm, S.M.A.R.T., and HDD full.

The maximum number of message recipient is 8.



Note Configuration first priority is always on “SCHEDULE” of “RECORD”. Thus, the system will not notify alarm message upon motion alarm or sensor even though user ticks the check-box of above event selection, unless user sets the “SCHEDULE” of “RECORD” and “MOTION”/“SENSOR” of “DEVICE” accordingly.

For example, If user sets just “Continuous” only in “SCHEDULE” of “RECORD” and tick “All” check-box of “REMOTE NOTIFY”, then the system will not notify alarm message. In this case, user has to set “CONT + MOT”, “MOTION”, “SENSOR”, or “CON + SENS” and then tick “ALL” check –box in order to enable REMOTE NOTIFY properly.

Note User can set remote pop-up in RemoteManager S/W(RMS) upon alarm trigger in DVR. In order for RMS user to receive an instant pop-up video over network from DVR, DVR user has to tick “SENSOR” or “MOTION ALARM” in above menu. “SENSOR” means the alarm triggered by physical alarm, while “MOTION ALARM” means the alarm triggered by motion detection.

E-Mail Notify

The system can make an email notification to the IP address of Remote Manager PC over the network.

User can choose various different kinds of alarms by pressing "ADD" for such as Log-in/Out, System start, Sensor, Video loss, Recording failure, Setup, Shutdown, Motion alarm, S.M.A.R.T., and HDD full.

The maximum number of email recipient is 8.



Note Configuration first priority is always on "SCHEDULE" of "RECORD".

Thus, the system will not email alarm message upon motion alarm or sensor even though user ticks the check-box of above event selection, unless user sets the "SCHEDULE" of "RECORD" and "MOTION"/"SENSOR" of "DEVICE" accordingly.

For example, If user sets just "Continuous" only in "SCHEUDLE" of "RECORD" and tick "All" check-box of "REMOTE NOTIFY", then the system will not make email notification. In this case, user has to set "CONT + MOT", "MOTION", "SENSOR", or "CON + SENS" and then tick "ALL" check -box in order to enable Email Notification properly.

4.5 Backup

4.5.1. Manual Backup

User can archive video clip recorded for certain period for a selected channel or channels as below picture. Connect an appropriate USB memory device like USB thumb drive/USB HDD, built-in CD or DVD burner and press "SCAN" button to get the system recognize it before actual archiving. Necessary file size will be shown before burning.

User can leave ticking in the check-box of "ADD VIEWER" to automatically put in an executable viewer file of EXE format in order to help user play the video clip without installing program in his/her computer, for the video file format is "SSF" that is manufacturer's own proprietary file format.



Note Backup device shall be built-in CD/DVD burner or well-known major brand of USB thumb drives formatted by FAT/FAT32 for proper backup. The system does not detect external HDD due to different format type.

Note DVD medias supportive are DVD+R, and DVD-R. DVD-RW/+RW are mostly not supportive.

Note User can easily backup video in "Quick Backup" during video playback. Refer to page 13 for quick backup details.

Note User can click "CHECK" button to learn the backup file size before executing backup.

4.5.2. Backup video retrieve

After archiving, there would be multiple files created as the picture below if "ADD VIEWER" was selected. User can double click "BackupPlayer.exe" file and open the video data file (SSF format) in the folder of date. The folder is named by the date recorded.



User can drag a SSF file(Video data file) and drop it in the empty screen of Backup Player as below picture to retrieve video play. Or, open the designated SSF file by clicking the left-bottom button.



User can print out, capture a still image, and zoom-out upon selection of the icons in the right bottom of the player screen.

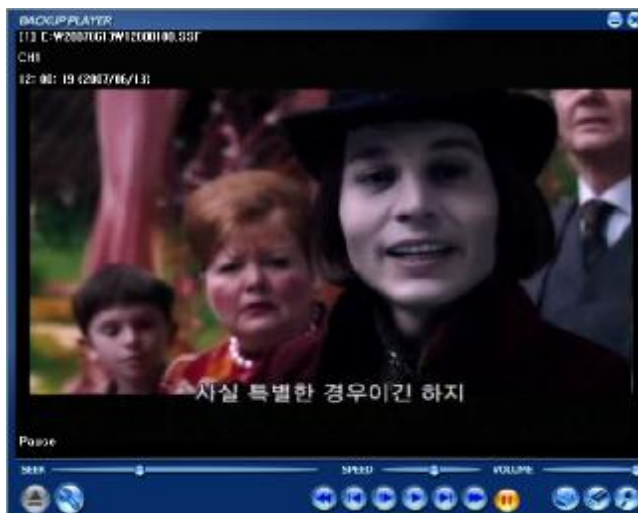

Note User also can play the backup-video clips by RemoteManager S/W (RMS).

Note There are some PCs that do not support "Direct Draw".
In this case, user can tick off in the check-box of DirectDraw in "Option".

User can select or not select “De-interlace” by mouse clicking of the right button as below, or check video resolution. User has to select “Audio Play” to retrieve audio data along with video playback in this sub-menu.

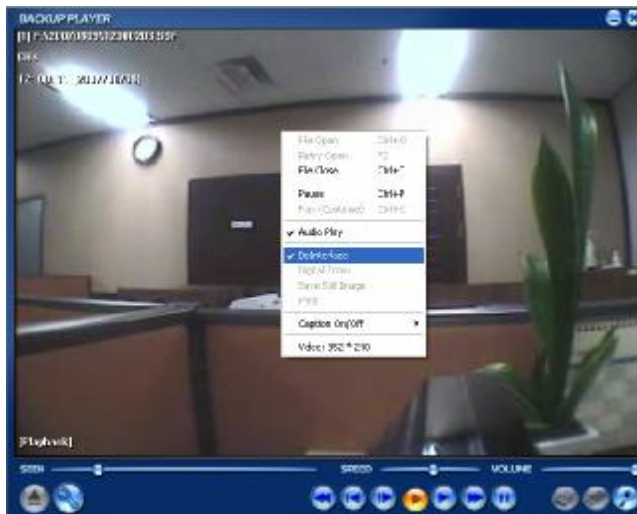

De-interlacing feature is widely required for smooth playback of video that is recorded by 720x480 (D1) resolution. The picture comparison below is how they are different between “Interlace” video and “De-interlace” video clip.



Note User can convert this backup file from SSF format to AVI format in RemoteManager S/W, so that user can playback AVI file in ordinary Window Media program with manufacturer’s own codec. Refer to the user’s manual of RemoteManager S/W for AVI conversion details.

4.6 Quick Setup

Quick Setup is to help user make simple configuration for recording resolution, entire recording speed by frame, recording mode, and recording periods.

The system will put the first priority of configuration on this quick setup and will follow this rule by quick setup beyond whatever user sets configurations in other menu. User shall not tick in the check-box of USE QUICK SETUP if he/she wants to utilize full system configuration set in other menus.



Note Quick setup shall be all de-activated if user needs to set by other full menu.

Note Once after user ticks "USE QUICK SETUP" to get its setting valid, then the system will ignore all other configurations set by full menus.

4.7 Web surveillance

The system has built-in web server by itself.

Thus, user can be always connected to the system by ordinary web-browser via network for either live monitoring or remote configuration without installing RemoteManager SW.

4.7.1. Web configuration

User is required to put the right IP address in the web browser after getting the web port available by router. After allowing the download of the Active-X file, user can find the log-in page view as below.

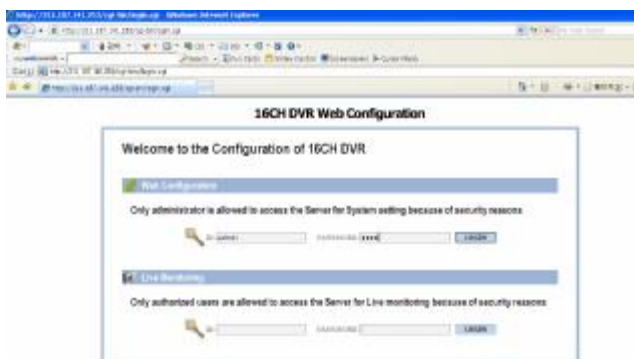

After log in with the right ID and password, user can make various configuration in Web Configuration window as below over the network. Default ID and password are "admin" and "1234". This Web Configuration is only available to "admin" account.



Note This DVR system has its own built-in web server. Therefore, this web CGI screen is directly supported from the built-in web server of DVR regardless of Internet connection.

Menu of Web Configuration

Main Classification	Sub Classification
SYSTEM	SYSTEM INFO
	USER
	FACTORY DEFAULT
	SYSTEM REBOOT
DEVICE	CAMERA
	AUDIO
	SENSOR
	MOTION ALARM
	EXTRA ALARM
RECORD	CAMERA
	SCHEDULE
NETWORK	NETWORK
	DDNS
	NOTIFICATION
QUICK SETUP	QUICK SETUP

Note <System Reboot> enables user to reboot the system without any change of the setup. User can use this function when the network is disconnected due to abnormal operation of the system and try to reconnect. However, IP number assigned to the system may be changed in case of DHCP mode.

4.7.2. Web monitoring

User has to download Active-X file from DVR and install it at workstation P/C before monitoring live video.



In order to download Active-X file from DVR without any problem, "Security Setting" of IE web browser has to be properly made. Select "Tools > Internet Options > Security > Internet > Custom Level" in IE menu and enable all Active-X controls and plug-in as below photo.



User can get into web monitoring by clicking "LIVE" button in the right top corner of the Web Configuration window, or by log-in in "Live Monitoring" window. In order to connect to DVR, user has to select the number of channel or select "ALL CHANNEL" in "LIVE MONITORING" as below, and then click "CONNECT" button.



User can monitor live video in 1, 4, 9 or 16 screen mode. If user wants to see single channel in full screen, then user can make double-clicks of the left mouse button positioned on the live video screen.

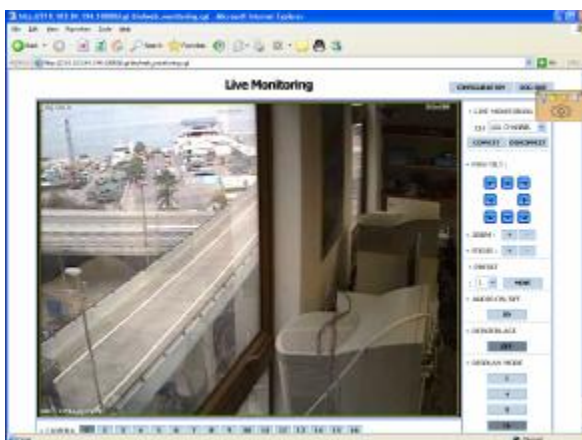
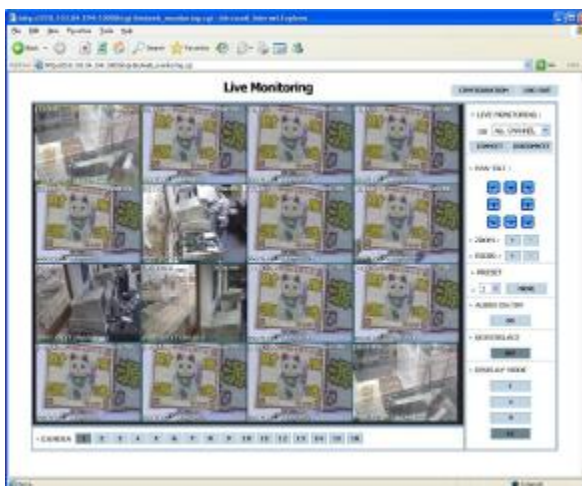

Note The image resolution in “Live monitoring” in this web browser is directly transferred from DVR. Therefore, user will see original resolution size set in DVR in single channel mode. In order to get full screen of CIF (352/320 x 240) video size, then user has to click right button of the mouse, and select “Full Screen” menu.



Note If live image is not properly shown on IE web browser due to network traffic jam or narrow bandwidth, it is recommended to close and re-open the IE web browser.

5. Specification

MODEL		4 Ch	8 Ch	16 Ch
Compression Algorithm		Video : Manufacturer's Proprietary Codec, Audio : G723.1		
HDD & CD/DVD Bay		3xHDD (Max) (2xHDD + 1xCD-RW/DVD)		
Operating System		Embedded Linux		
Video	Input	4 Ch	8 Ch	16 Ch
	Loop-Out	4 Ch (Built-in)	8 Ch D-Sub (Option)	2 x 8 Ch D-Sub (Option)
Video Mode		NTSC/PAL Selectable		
Display Speed (NTSC/ PAL)		120/100 fps (Real-Time Display)	240/200 fps (Real-Time Display)	480/400 fps (Real-Time Display)
Screen Modes for Live Display		1, 4 & PIP	1, 4, 9 & PIP	1, 4, 9, 16 & PIP
Monitor Output		Main Monitor Output (Composite, S-VHS & VGA) Spot Monitor Output (Composite) VGA Monitor Resolution : 640x480, 800x600, 1024x768 & 1280x1024 (Selectable)		
Max.Recording Speed (NTSC/ PAL)	352x240/288	120/100 fps	240/200 fps	240/200 fps
	720x240/288	120/100 fps	120/100 fps	120/100 fps
	720x480/576	60/50 fps	60/50 fps	60/50 fps
Recording Resolution		NTSC : 352x240, 720x240, 720x480, PAL : 352x288, 720x288, 720x576		
Recording Modes		Continuous, Scheduled, Sensor-Activated & Motion Detection Recording Pre & Post Alarm Recording, Emergency Recording , Quick Backup		
Playback & Search	Speed	x1, x2, x4, x8, x16, x32		
	Function	1, 4, 9 & 16 Ch (Multi-Channel Playback) Intelli-Search by Time Bar, Calendar (Date & Time) and Event/system Search		
Audio Input / Output		4 Ch Input / 1 Ch Output		
Alarm I/O & Camera Connection		M : N Mapping		
Alarm Input / Output		4 Ch / 4 Ch	8 Ch / 4 Ch	16 Ch / 4 Ch
P/T/Z Control and Port		Virtual Joy-Stick Control on screen by mouse Pan/Tilt/Zoom/Focus/Iris, RS-485 Port		
LAN		10/100 Base-Tx Ethernet (RJ45) – Fixed IP, DHCP & DDNS		
Network	Function	Multi-to-Multi Connection, Multi-Channel Transmission Live Monitoring, Remote Playback and File Backup (Triplex-on-Remote) Remote & E-Mail Notification, Remote System Reboot by IE		
Remote PTZ Control		Pan/Tilt/Zoom/Focus/Iris (World Famous PTZ Protocol are Available)		
Remote Management		Remote Configuration, Live Monitoring, E-Map & System Healthy Checking		
Backup Device	Internal	CD-RW and DVD (Option)		
	External	USB Memory Stick (by USB 2.0 Port at Front & Rear Plate)		
System Recovery after Power Failure		Auto-Reboot and Journaling File System Auto-Scan and Data Recovery		
Advanced Functions		Multi-Language, Auto Page Sequencing, Event Log Viewer, Access Control by Password, LED Indicator for Various status, System Upgrade by USB/Network, System & Event Log Export (txt file) Configuration Import/Export, Water-Mark, AVI File Backup System & HDD Temperature Checking and Auto Alarm for Over-Temperature		
System Operation		Button on Front Panel, IR remote Controller, USB Mouse CCTV Keyboard (Option)		

MODEL	4 Ch	8 Ch	16 Ch
Storage Temperature and Humidity	-20~60℃ / 20~95 % RH		
Operating Temperature and Humidity	5~40℃ / 20~80 % RH		
Power	DC 12V, 5A, 50~60 Hz	DC12V, 7~8A, 50~60Hz	
Dimension (WxDxH) and Weight	360x450x70 mm & 4.3 Kg		
Remote Software	RMS-16 Ch (Remote Monitoring S/W), IE Web Browser CMS-64 Ch (Central Management S/W) with Multiple Monitors Supported		
Certifications	CE, FCC & MIC & WEEE, RoHS		

※ The specifications are subject to change without prior notice (Dependent on model & chassis)