

AVerMedia®

AVerDiGi EB1304 MOB

Mobile Security DVR System

User Manual



FCC NOTICE (Class B)



This device complies with Part 15 of the FCC Rules. Operation is subject to the following two conditions: (1) this device may not cause harmful interference, and (2) this device must accept any interference received, including interference that may cause undesired operation.

Federal Communications Commission Statement

NOTE- This equipment has been tested and found to comply with the limits for a Class B digital device, pursuant to Part 15 of the FCC Rules. These limits are designed to provide reasonable protection against harmful interference when the equipment is operated in a commercial environment. This equipment generates, uses and can radiate radio frequency energy and, if not installed and used in accordance with the instructions, may cause harmful interference to radio communications. Operation of this equipment in a residential area is likely to cause harmful interference in which case the user will be required to correct the interference at his own expense.

CAUTION ON MODIFICATIONS

To comply with the limits for the Class B digital device, pursuant to Part 15 of the FCC Rules, this device must be installed in computer equipment certified to comply with the Class B limits. All cables used to connect the computer and peripherals must be shielded and grounded. Operation with non-certified computers or non-shielded cables may result in interference to radio or television reception.

Changes and modifications not expressly approved by the manufacturer could void the user's authority to operate this equipment.

European Community Compliance Statement (Class B)



This product is conformity with the protection requirements of EU Council Directives 89/336/EEC amended by 92/31/EEC on the laws of the Member States relating to electromagnetic compatibility.

Warning - This is a Class B product. In a domestic environment this product may cause radio interference in which case the user may be required to take adequate measures to correct this interference.

DISCLAIMER

No warranty or representation, either expressed or implied, is made with respect to the contents of this documentation, its quality, performance, merchantability, or fitness for a particular purpose. Information presented in this documentation has been carefully checked for reliability; however, no responsibility is assumed for inaccuracies. The information contained in this documentation is subject to change without notice.

In no event will AVerMedia be liable for direct, indirect, special, incidental, or consequential damages arising out of the use or inability to use this product or documentation, even if advised of the possibility of such damages.

TRADEMARKS

AVerMedia is registered trademarks of AVerMedia TECHNOLOGIES, Inc. IBM PC is a registered trademark of International Business Machines Corporation. Macintosh is a registered trademark of Apple Computer, Inc. Microsoft is a registered trademark and Windows is a trademark of Microsoft Corporation. All other products or corporate names mentioned in this documentation are for identification and explanation purposes only, and may be trademarks or registered trademarks of their respective owners.

COPYRIGHT

© 2006 by AVerMedia TECHNOLOGIES, Inc. All rights reserved. No part of this publication may be reproduced, transmitted, transcribed, stored in a retrieval system, or translated into any language in any form by any means without the written permission of AVerMedia TECHNOLOGIES, Inc.



THE MARK OF CROSSED-OUT WHEELED BIN INDICATES THAT THIS PRODUCT MUST NOT BE DISPOSED OF WITH YOUR OTHER HOUSEHOLD WASTE. INSTEAD, YOU NEED TO DISPOSE OF THE WASTE EQUIPMENT BY HANDING IT OVER TO A DESIGNATED COLLECTION POINT FOR THE RECYCLING OF WASTE ELECTRICAL AND ELECTRONIC EQUIPMENT. FOR MORE INFORMATION ABOUT WHERE TO DROP OFF YOUR WASTE EQUIPMENT FOR RECYCLING, PLEASE CONTACT YOUR HOUSEHOLD WASTE DISPOSAL SERVICE OR THE SHOP WHERE YOU PURCHASED THE PRODUCT.

Battery Safety Information

- Store the batteries in a cool dry place.
- Do not dispose of used batteries in domestic waste. Dispose of batteries at special collection points or return to point of sale if applies.
- Remove the batteries during long periods of non-use. Always remove exhausted batteries from the remote control. Battery leakage and corrosion can damage this remote control, dispose of batteries safely.
- Do not mix old and new batteries.
- Do not mix different types of batteries: alkaline, standard (carbon-zinc) or rechargeable (nickel-cadmium).
- Do not dispose of batteries in a fire. The batteries may explode or leak.
- Never short circuit the battery terminals.

**WARNING**

TO REDUCE RISK OF FIRE OR ELECTRIC SHOCK, DO NOT EXPOSE THIS APPLIANCE TO RAIN OR MOISTURE.

**CAUTION**

IF THERE IS ANY DAMAGE, SHORTAGE OR INAPPROPRIATE ITEM IN THE PACKAGE, PLEASE CONTACT WITH YOUR LOCAL DEALER. WARRANTY VOID FOR ANY UNAUTHORIZED PRODUCT MODIFICATION.

**NOTICE**

- INFORMATION IN THIS DOCUMENT IS SUBJECT TO CHANGE WITHOUT NOTIEC.
- THE INFORMATION CONTAINED HEREIN IS TO BE CONSIDERED FOR REFERENCT ONLY.

Table of Contents

Chapter 1 Introduction	1
1.1 Package Content	1
1.2 Features and Specifications	2
1.3 Front Panel	3
1.4 Back Panel	4
1.5 Setting Up the DVR Unit	5
1.5.1 Installing the Hard Disk	5
1.5.2 Mounting the DVR Unit	6
1.5.3 Connecting Devices	7
1.5.4 Connecting the Sensor/Relay device	8
1.6 Familiarizing the Remote Control Buttons	9
Chapter 2 Operating the EB1304 MOB	11
2.1 Using the EB1304 MOB for the First Time	11
2.1.1 Select the Setup Mode and Video System	11
2.1.2 Formatting Hard Disk	11
2.1.3 Set up the System Date and Time	12
2.2 Surveillance Screen	12
2.3 Playback the Video	12
2.3.1 To Playback Video	13
Chapter 3 OSD Navigation Tree	15
3.1 Menu Function	15
Chapter 4 Setup DVR in LED Mode	22
4.1 LED Panel Message Definition	28
Chapter 5 Using USB Playback Console	29
5.1 Recommended system requirements	29
5.2 Installing the USB Playback Console	29
5.3 Running the USB Playback Console	30
5.3.1 To Cut and Save the Portion of the Recorded Video	32
5.3.2 Playback DVR Recorded File from Hard Disk	32
5.3.3 Playback Backup File(*.dvr)	33
5.4 To Backup Recorded Video File	33
Chapter 6 Using ImageVerification	36
6.1 To Run the ImageVerification	36
Chapter 7 Using i-Enhance	37
7.1 To Use i-Stable	38

Chapter 1 Introduction

AVerDiGi EB1304 MOB is a 4-channel stand-alone DVR unit for mobile solution that can be installed on the vehicle for security monitoring. It provides real-time monitoring and digital recording of surveillance video. Up to four video cameras and four sensor devices can be hooked up to this DVR unit. It also provides one audio input and output channel.

DVR unit can be controlled through the LED panel with remote control. Also, With the On-Screen-Display (OSD) menu, user can customize video recording setting, sensor and alarm settings, password protection, hard drive recycling, and more.

Surveillance video is recorded in high-quality MPEG4 format. Two recording modes are supported; **D1** Mode can record video from each video camera in higher resolution (720 x 480 / 720 x 576) at 60/50 fps and **CIF** Mode can record video in lower resolution (360 x 240 / 360 x 288) and up to 120/100 fps (NTSC/PAL).

1.1 Package Content



(1)



(2)

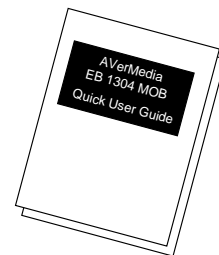

(3)

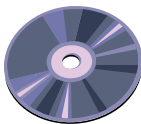

(4)



(5)

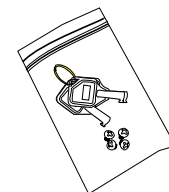

(6)



(7)



(8)



(9)



(10)

- (1) AVerMedia® AVerDiGi EB1304 MOB unit
- (2) Remote Control (batteries included)
- (3) Quick Installation Guide
- (4) Software CD (User Manual included)
- (5) Z-bracket x 2 (including 4 screws)
- (6) Removable hard disk drawer accessories (with spare screws)
- (7) Power cable
- (8) Camera Power cable
- (9) Extended IR Sensor cable
- (10) USB cable



1.2 Features and Specifications

- Non-PC stand-alone security digital video recorder
- 4 composite video inputs and 1 composite output
- VGA output for LCD monitor display
- Front LED setup panel
- On-Screen-Display menu interface
- MPEG4 video compression
- Manually-switch NTSC or PAL video system
- Supports 1 hard drive (not included)
- Full-screen resolution:
 - Display:** 720 x 480 (NTSC), 720 x 576 (PAL)
 - Recording:** 720 x 480 (NTSC), 720 x 576 (PAL)
- Display frame rate:
 - Total of 120/100 fps (NTSC/PAL)
- Recording frame rate:
 - D1 mode (720 x 480 / 720x576):** total of 60/50 fps (NTSC/PAL)
 - CIF mode (360 x 240 / 360x288):** total of 120/100 fps (NTSC/PAL)
- Scheduled recording (00:00~23:00 set by hour)
- Motion detection recording
- Search for recorded files by date/time/event
- Input/Output: 4 sensor inputs and 1 relay output control
- 12 ~ 24V DC input

- Removable hard disk drawer
- Multiple language OSD
- One USB 2.0 port for backup or playback

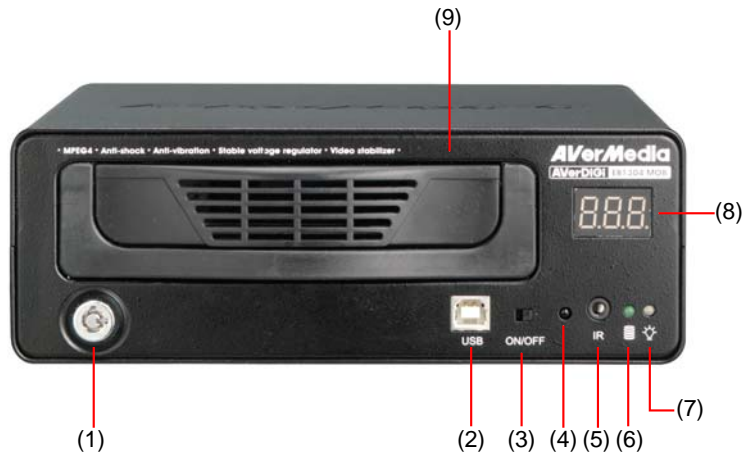

1.3 Front Panel

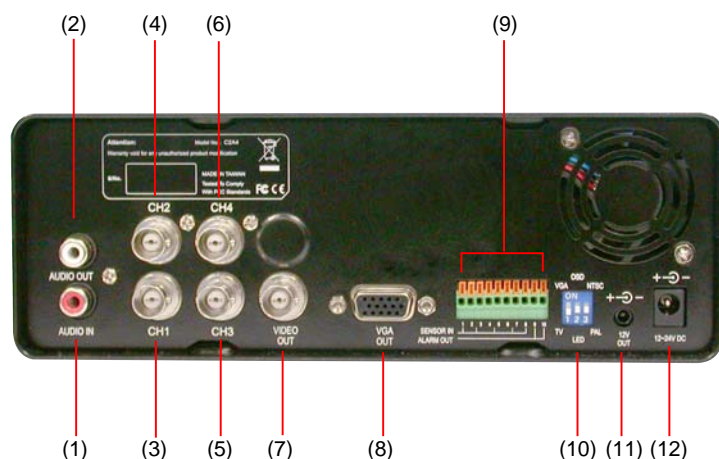

Name	Function
(1) Removable HDD Keylock	: Lock/unlock the hard disk rack
(2) USB 2.0 Port	: Connect to PC for video backup or playback
(3) Power Switch	: Power on / off the DVR unit
(4) IR Sensor	: Receive signal from the remote control to operate the unit
(5) IR Sensor Port	: To connect extended IR sensor cable
(6) HDD LED 	: Indicate running state of the hard disk. Lights when the HDD is running
(7) DVR Power LED 	: Lights when the unit is on
(8) LED Control Panel	: To configure DVR unit without connecting to monitor. Also, LED panel will display HDD usage and DVR system temperature.
(9) Removable HDD Drawer	: Hot swap removable Hard disk slot
	<div style="border: 1px solid black; padding: 5px;">  <p>The DVR unit support hard disk hot swap. User can unlock the hard disk key lock and swap the hard disk during the DVR unit is running. The DVR system will stop recording and shutdown hard disk when the hard disk key lock is unlocked. Remove the hard disk when the hard disk stop message display on the screen.</p> </div>

1.4 Back Panel



Name	Function
(1) Audio In	: Input the audio signal from a microphone or audio output device. The audio is embedded with channel 1 <div style="border: 1px solid black; padding: 5px; margin-top: 10px;">  The audio input device must be power supplied by external power. </div>
(2) Audio Out	: Output the audio signal to a speaker <div style="border: 1px solid black; padding: 5px; margin-top: 10px;">  The audio output device must be power supplied by external power. </div>
(3) CH1	: Input the video camera signal and display it on channel 1
(4) CH2	: Input the video camera signal and display it on channel 2
(5) CH3	: Input the video camera signal and display it on channel 3
(6) CH4	: Input the video camera signal and display it on channel 4
(7) Video Out (BNC)	: Output the video signal to a TV <div style="border: 1px solid black; padding: 5px; margin-top: 10px;">  The DVR unit support 2 video output ports and you can only select to output the video either from the VGA OUT or VIDEO OUT </div>
(8) VGA Out	: Output the video signal to a CRT or LCD monitor
(9) Sensor In & Alarm Out	: Support up to 4 sensor device and 1 relay device (Relay: 1A @ 125V AC/30V DC)
(10) TV-VGA/OSD-LED/NTSC-PAL Switch	: Switch to select the video output, setup mode (OSD/LED panel, also see Chapter 2.1.1), and video system(NTSC/PAL) Make sure to set the video output, setup mode, and video system before turning on the unit
(11) 12V Out	: Connect the camera power cable to supply power for cameras
(12) 12 ~ 24V DC	: Connect the power cable to this port. The power cable connects to vehicle battery for supplying the power to DVR unit.

1.5 Setting Up the DVR Unit

1.5.1 Installing the Hard Disk

The DVR unit allows you to install one hard disk. Before installing the hard disk, make sure to set the hard disk master/slave jumper setting. Adjust the jumper setting according to the instructions on the hard disk label. Please set the jumper of hard disk as **Master**. Follow the illustrated instructions below to install the hard disk:

1. Using key to unlock the hard disk key lock
2. Pull removable hard disk drawer out lock

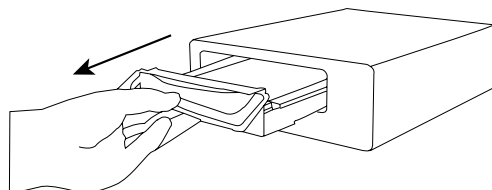
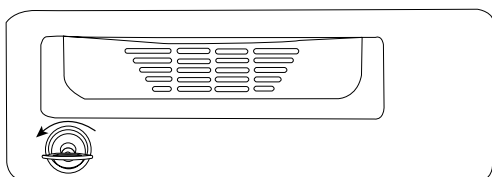

3. Connect the power connector to the hard disk (master)
4. Connect the IDE cable to hard disk

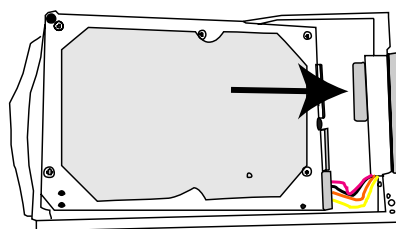
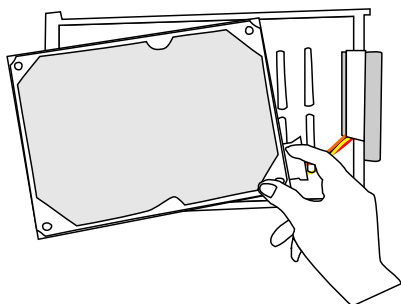

5. Turn the drawer over and secure the hard disk with 4 screws on the hard disk removable drawer
6. Slide the drawer back

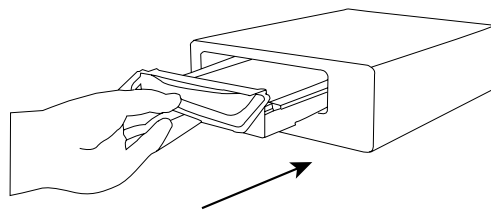
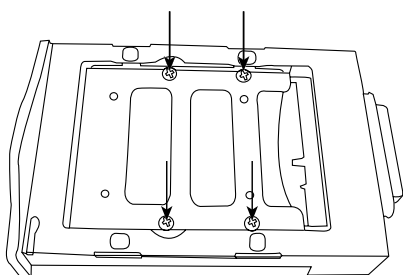

7. Using key to lock the hard disk key lock
8. You may now connect all the cables. When the power is connected, the Power LED light  turns on

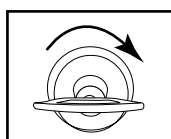

- Use 40GB/ 7200RPM IDE hard disk or larger is recommended.
- The DVR unit support hard disk hot swap. Therefore, user can swap the hard disk without shutdown the DVR unit.

1.5.2 Mounting the DVR Unit

The DVR unit can be mounted in two ways. User can uses the Z-brackets (4 screws included) to mount the DVR unit as the figure show below.



1.5.3 Connecting Devices

The DVR unit can connect up to 4 video cameras, 4 sensor devices, 1 alarm device and output video to a TV or CRT/LCD monitor. Follow the illustration below to make the connection:

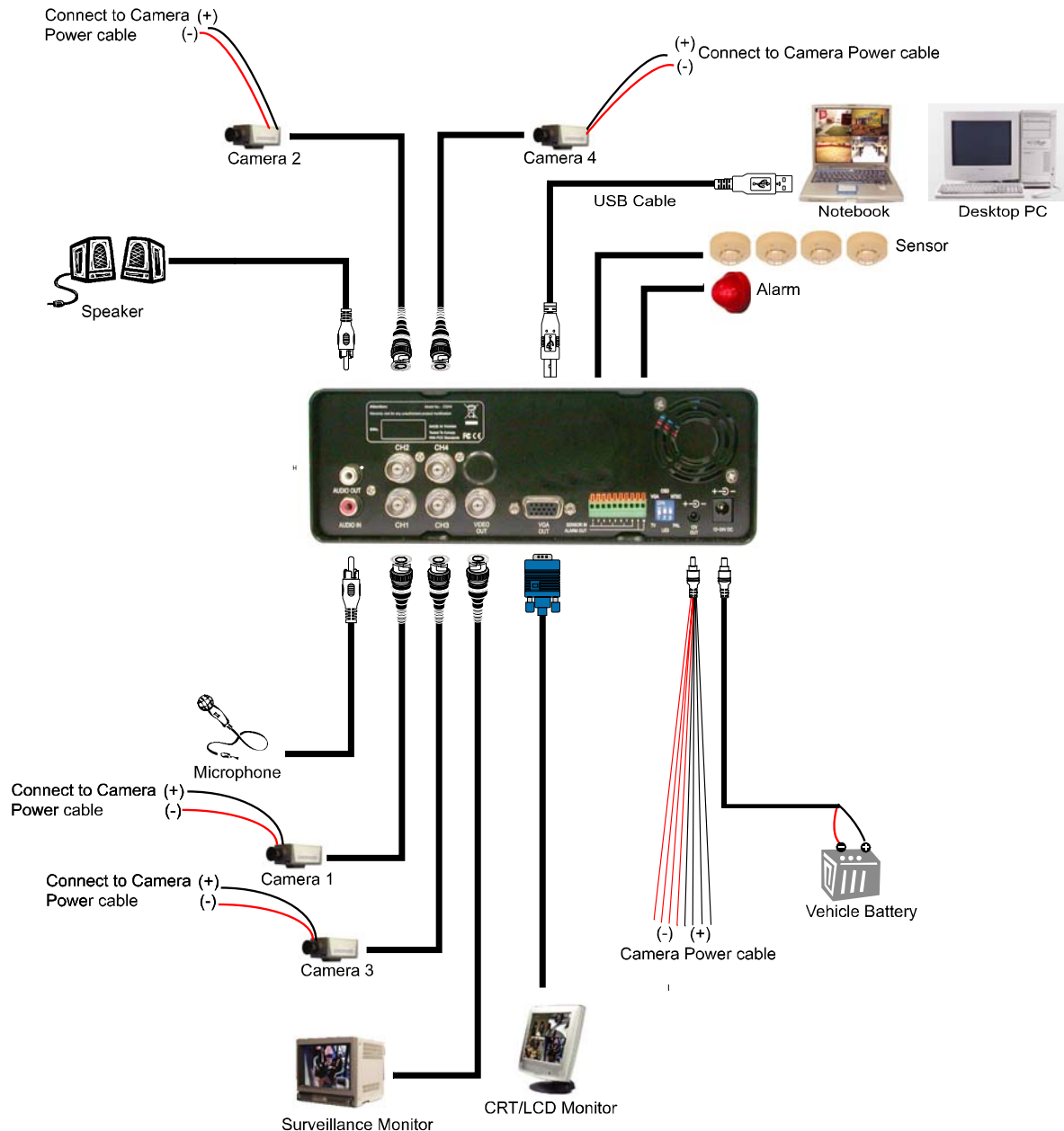

- Each time you change the video display output, the power must be turned **off** and **on** to reset the DVR unit.
- When the power cable is connected to vehicle battery, remember to stop recording and shutdown the DVR unit to avoid running out of vehicle battery when the vehicle engine is off.

1.5.4 Connecting the Sensor/Relay device

The Sensor and Alarm ports enable you to connect (4) sensor inputs and (1) relay outputs. Just connect the external sensor and relay pin directly to the pinhole. Check the table below and locate which pinhole is assigned to sensor input and relay output.

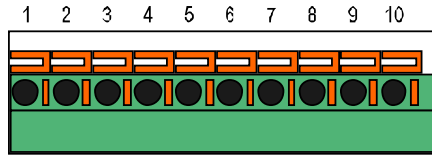

1.5.4.1 I/O Card Sensor and Relay pinhole allocation:

The signal from the sensor (i.e., infrared sensors, smoke detectors, proximity sensors, door sensors, etc.) is being transmitted to the unit and this triggers the system to respond and send signal to relay device (i.e., alarm, telephone etc).







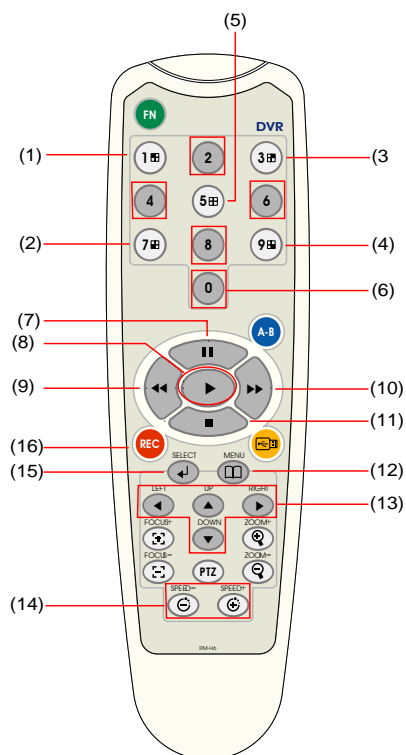





Pin #	Definition
1	Sensor 1 Ground signal
2	Sensor 1 signal
3	Sensor 2 Ground signal
4	Sensor 2 signal
5	Sensor 3 Ground signal
6	Sensor 3 signal
7	Sensor 4 Ground signal
8	Sensor 4 signal
9	Relay signal
10	Relay signal

1.6 Familiarizing the Remote Control Buttons

Use the Remote control to operate the OSD menu on surveillance screen.



Button	Function
(1)	Switch to Channel 1 As a number key for entering password
(2)	Switch to Channel 2 As a number key for entering password
(3)	Switch to Channel 3 As a number key for entering password
(4)	Switch to Channel 4 As a number key for entering password
(5)	Switch to QUAD mode As a number key for entering password
	As a number key for entering password
(6)	
(7)	Pause the playing To move the select to up

Button	Function
(8) 	To play the video
(9) 	Reverse the video playback at the speed of 2x, 4x 8x or 16x
	To move the select to left
(10) 	Fast play the video playback at the speed of 2x, 4x 8x or 16x
	To move the selection to right
(11) 	Stop playing / Stop recording
	To move the select to down
(12) 	To enter the OSD Main menu / Exit from the main menu or sub-menu display
(13)    	To move the selection to the left and right
	To go up and down and select the items in the menu list or change the settings
	 To switch to display system temperature in LED mode
	 To switch to display hard disk capacity in LED mode
(15) 	Make a selection
	Enter sub-menu
(16) 	Start video recording

Chapter 2 Operating the EB1304 MOB

2.1 Using the EB1304 MOB for the First Time

For the first time using the DVR unit, suggest user connect with the monitor and setup DVR unit by OSD menu. Once the DVR unit has been set up, user can use LED panel with remote control to modify setup of DVR unit.

2.1.1 Select the Setup Mode and Video System

Before starting setup the DVR unit, please select the setup mode and video system. DVR unit has two setup modes – OSD and LED mode. By adjusting switch, user can change the setup mode. The following figure shows the setup mode switch setting.

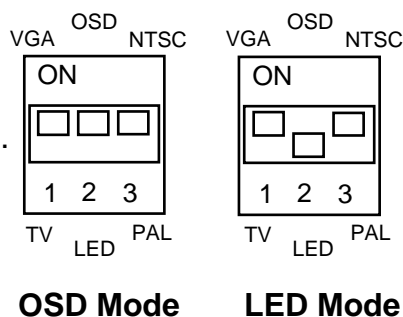



The DVR unit supports two system types – NTSC and PAL. Please select the correct video system before power on the unit.



Before set up the DVR unit, please make sure the setup mode that is the one user wants to use. Otherwise, the DVR unit won't be able to receive remote control signal correctly.





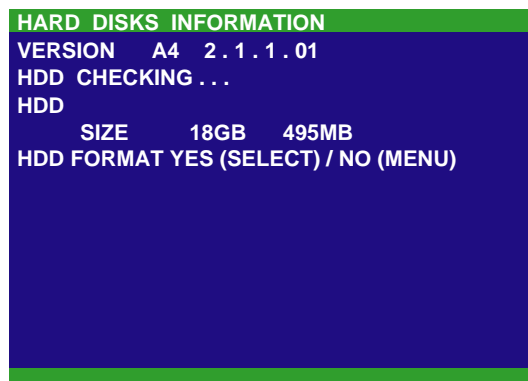





2.1.2 Formatting Hard Disk

Upon connecting the power, the unit automatically detects the status of the hard disk. The hard disk must be formatted for the first time using with DVR unit. If you are prompt to format the hard disk, press  (select) for **YES** to format the hard disk and  (menu) for **NO** to remain unchanged.





2.1.3 Set up the System Date and Time

Before starting record video, adjust the date and time first.

1. Press  to call up the OSD menu and then use  and  to go up and down and select Submenu. And then, press  to confirm the selection.
2. In Submenu, select the Date and press  again to make a selection. And then, use  and  to adjust the date and use  and  buttons to move the selection to the left and right.
3. To adjust Time, follow the above step 2 and 3.
4. Press  to go back to main menu after adjustment.

2.2 Surveillance Screen

User can switch to display each channel in full screen or 4 channels at the same time in D1 or CIF record mode.

To know if the channel is being recorded, the “●” record symbol would appear beside the channel number. The  (microphone) and  (speaker) indicate the availability of audio. The information below the screen shows the current date and time, recording mode (record schedule setting), hard disk drive (Master/Slave) and the percentage of the used hard disk space.

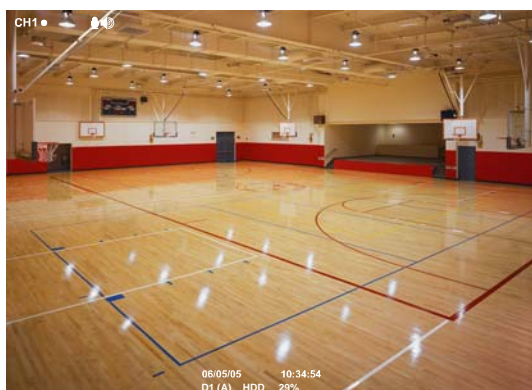

Full screen Preview

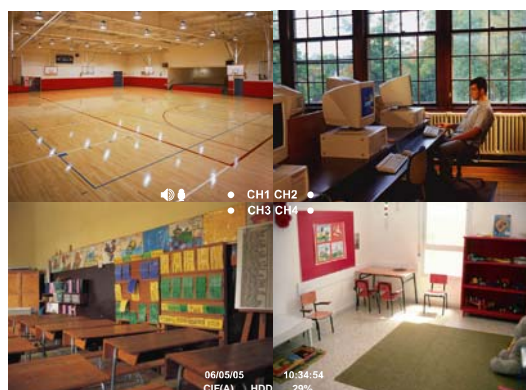

Quad Screen Preview

When you are in full screen preview, press the following buttons on the remote control and control panel to switch to different channel, or preview all 4 channels:



CH1: Camera 1



CH2: Camera 2



CH3: Camera 3



CH4: Camera 4



QUAD:4-Channel

2.3 Playback the Video







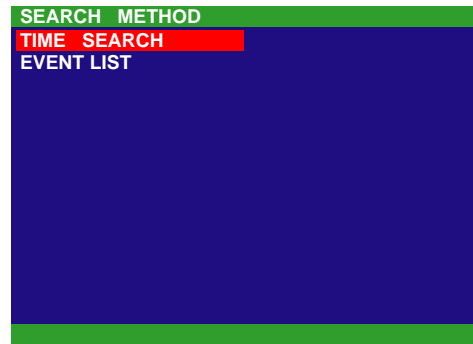





















If the unit is recording the video, you may have to stop video recording in order to do video playback. To stop video recording, press .

2.3.1 To Playback Video

1. Press  (play).
2. Use the  and  or  and  buttons to go up and down and select **TIME SEARCH** or **EVENT LIST**. Then, press  or  (play) to make a selection.







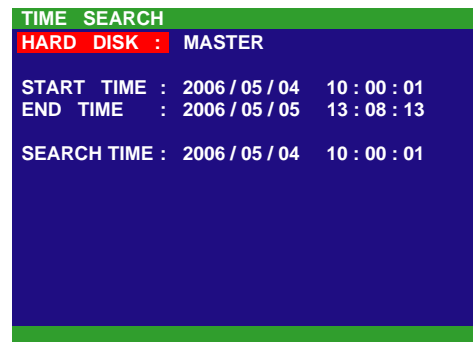







TIME SEARCH (search by date and time):

1. In the selected **HARD DISK**, press  or . Then, use the  and  or  and  buttons to select **MASTER** or **SLAVE**. Press  or  (play) again to make the selection. The **START TIME** and **END TIME** show the date and time from when the recording begins and ends.
2. Use the  and  or  and  buttons and select **SEARCH TIME**. Then press  or  (play) again to make the selection.
3. In the **SEARCH TIME**, you may now select the date and time from where you want to begin the video playback. Use  and  buttons to move the selection to the left and right. Use the  and  or  and  buttons to select the date and time. Then press  or  (play) again to make the selection.
4. To start video playback, the time in second must be set. Use the  buttons to move the selection to the left most. Use the  and  or  and  buttons and select the time in second. Then press  or  (play).



EVENT LIST (search by condition):

1. In the selected **HARD DISK**, press  or  (play). Then, use the  and  or  and  buttons to move the selection up and down. To go to next page, use  and  or  and  buttons. Press  or  (play) again to make the selection.

EVENT LIST			
HARD DISK : MASTER			
S	2006 / 05 / 03	13 : 26 : 34	13 : 26 : 50
A	2006 / 05 / 03	13 : 00 : 01	13 : 16 : 46
A	2006 / 05 / 03	12 : 00 : 01	13 : 00 : 01
B	2006 / 05 / 03	11 : 48 : 37	12 : 00 : 00
A	2006 / 05 / 03	11 : 30 : 23	11 : 31 : 18
A	2006 / 05 / 03	11 : 29 : 47	11 : 30 : 13
M	2006 / 05 / 03	11 : 28 : 55	11 : 28 : 58
M	2006 / 05 / 03	11 : 28 : 33	11 : 28 : 55
A	2006 / 05 / 03	11 : 25 : 41	11 : 28 : 32
A	2006 / 05 / 03	11 : 23 : 26	11 : 23 : 30





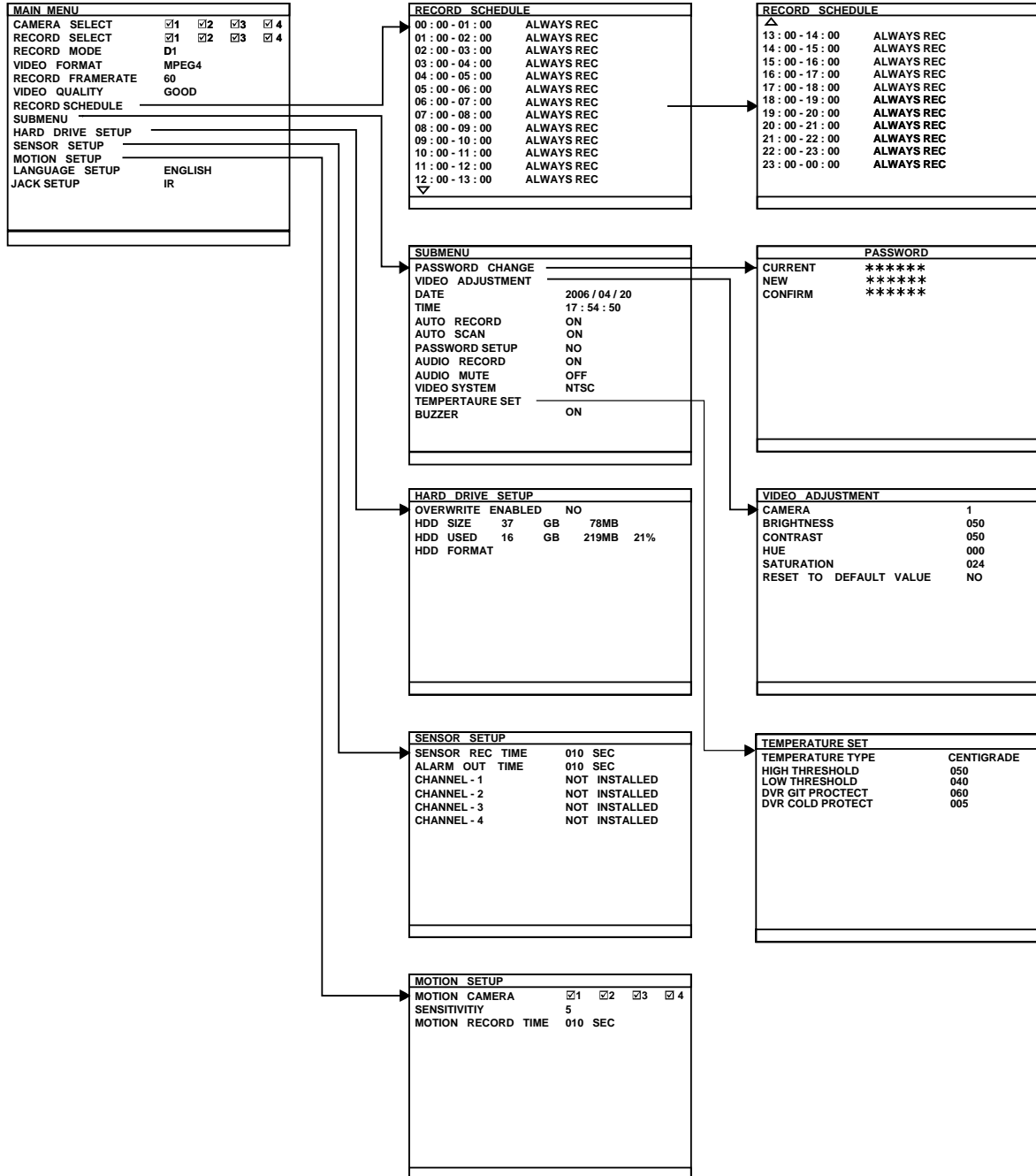

2. Listed below are the following recording conditions:
 - A – Always Recording
It records non-stop and automatically continue recording when interrupted.
 - S – Sensor Recording
It records when the sensor has activated.
 - M – Motion Recording
It records when any movement is detected
 - B – Button Recording
It records when the  record button is pressed.
3. The “▶” play symbol would appear beside the channel number when you are in playback mode.



Chapter 3 OSD Navigation Tree

The follow figure is an OSD menu tree map. To call out the OSD menu, press  button on the remote control.



3.1 Menu Function

To navigate in the OSD menu, press  to call up and exit from the main menu or sub-menu display. Then use the  and  or  and  buttons to go up and down and select the items in the menu list or change the settings. Use  or  (play) button to enter sub-menu or make a selection. User can also use

the  and  buttons to move the selection to the left and right. The red frame turns yellow when users are making a selection.



If the unit is currently recording the video, user may have to stop video recording to change the settings.

OSD MENU	Description
MAIN MENU CAMERA SELECT <input checked="" type="checkbox"/> 1 <input checked="" type="checkbox"/> 2 <input checked="" type="checkbox"/> 3 <input checked="" type="checkbox"/> 4 RECORD SELECT <input checked="" type="checkbox"/> 1 <input checked="" type="checkbox"/> 2 <input checked="" type="checkbox"/> 3 <input checked="" type="checkbox"/> 4 RECORD MODE D1 VIDEO FORMAT MPEG4 RECORD FRAMERATE 60 VIDEO QUALITY GOOD RECORD SCHEDULE SUBMENU HARD DRIVE SETUP SENSOR SETUP MOTION SETUP LANGUAGE SETUP ENGLISH JACK SETUP IR	CAMERA SELECT : Enable/disable the channel number to display the video on the surveillance screen. RECORD SELECT : Enable/disable the channel number to record video. <div style="border: 1px solid black; padding: 5px; display: inline-block;">  The channels that are enabled in the camera select setting can only be set for video recording. </div>

RECORD MODE :

Select **D1/CIF** recording mode

Under **D1** mode, the video recording is in full screen resolution and takes turns from one channel to the next one when Auto Scan enables. Each channel is recorded only at a maximum frame rate of 15fps. User can switch to view the video in single full screen or QUAD screen

Whereas in **CIF** mode, video recording is at a lower resolution, but each video is recorded in 30fps/25fps (NTSC/PAL). User can switch to view the video in single full screen or QUAD screen

VIDEO FORMAT :

The recorded video is in MPEG4 format.

RECORD FRAME RATE :

Set the number of frames per second to be recorded. Refer to the table below for the available record frame rate settings. The higher the frame rate, it uses more hard disk space.

Video Standard \ Record Mode	NTSC	PAL
D1	60, 20, 4	48, 20,4
CIF	120, 60,40, 20, 4	100, 48, 20, 4

VIDEO QUALITY :

Select the video quality setting from BEST, HIGH, GOOD, MEDIUM, NORMAL or LOW.

Choosing **NORMAL** allows user to record more hours but the quality of the recorded video is moderate.

LANGUAGE SETUP :

Select from the available language

JACK SETUP

The DVR unit provides a jack port for external extend line for system LED indicator or IR receiver. It is convenient for user to easily indicate the DVR unit status or remote control the DVR unit when the DVR unit is installed at hide place. Select LED for external extent system LED indicator line or IR for external remote control receiver line.



The external LED indicator line is optional. The external IR receiver line is included in package contents.

RECORD SCHEDULE	
00 : 00 - 01 : 00	ALWAYS REC
01 : 00 - 02 : 00	ALWAYS REC
02 : 00 - 03 : 00	ALWAYS REC
03 : 00 - 04 : 00	ALWAYS REC
04 : 00 - 05 : 00	ALWAYS REC
05 : 00 - 06 : 00	ALWAYS REC
06 : 00 - 07 : 00	ALWAYS REC
07 : 00 - 08 : 00	ALWAYS REC
08 : 00 - 09 : 00	ALWAYS REC
09 : 00 - 10 : 00	ALWAYS REC
10 : 00 - 11 : 00	ALWAYS REC
11 : 00 - 12 : 00	ALWAYS REC
12 : 00 - 13 : 00	ALWAYS REC
▼	





RECORD SCHEDULE:

By default, in 24 hours, the recording schedule is set to always record every hour. Refer to the table below to customize the recording condition.





Condition	Description
NO REC	Disable video recording.
ALWAYS REC	Record non-stop.
MOTION REC	Start recording when any movement is detected
SENSOR REC	Start recording when the sensor is activated.

SUBMENU	
PASSWORD CHANGE	
VIDEO ADJUSTMENT	
DATE	2006 / 12 / 11
TIME	17 : 54 : 50
AUTO RECORD	ON
AUTO SCAN	ON
PASSWORD SETUP	NO
AUDIO RECORD	ON
AUDIO MUTE	OFF
VIDEO SYSTEM	NTSC
TEMPERATURE SET	
BUZZER	ON

PASSWORD CHANGE :

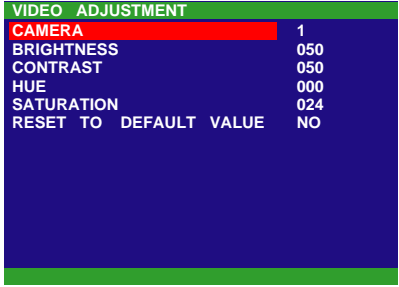
Set a security combination number. This is a security measure that prevents formatting of the hard disk or changing the system settings. The factory default password is 111111. User could use number key (0 1 2 3 4 5 6 7 8 9) on the remote control to enter each digit of password. Or, use  and  or  and  to set the password.

PASSWORD	
CURRENT	*****
NEW	*****
CONFIRM	*****

OSD MENU	Description
<p>SUBMENU</p> <p>PASSWORD CHANGE</p> <p>VIDEO ADJUSTMENT</p> <p>DATE 2006 / 12 / 11</p> <p>TIME 17 : 54 : 50</p> <p>AUTO RECORD ON</p> <p>AUTO SCAN ON</p> <p>PASSWORD SETUP NO</p> <p>AUDIO RECORD ON</p> <p>AUDIO MUTE OFF</p> <p>VIDEO SYSTEM NTSC</p> <p>TEMPERATURE SET</p> <p>BUZZER ON</p>	<p>VIDEO ADJUSTMENT :</p> <p>Select the camera number and set to adjust the video brightness, contrast, hue, and saturation value.</p>  <p>VIDEO ADJUSTMENT</p> <p>CAMERA 1</p> <p>BRIGHTNESS 050</p> <p>CONTRAST 050</p> <p>HUE 000</p> <p>SATURATION 024</p> <p>RESET TO DEFAULT VALUE NO</p>
	<p>DATE :</p> <p>Set the current date.</p> <hr/> <p> Please set the correct date and time when you use the DVR system at the first time to make sure the time of recorded video file is correct.</p> <hr/>
	<p>TIME :</p> <p>Set the current time.</p>
	<p>AUTO RECORD :</p> <p>Enable/disable auto continue recording when interrupted (i.e., power breakdown, video playback or configuration setup). It starts to record after 10 second of idleness. This is applicable in Always Record mode.</p>
	<p>AUTO SCAN :</p> <p>Enable/disable auto cycle switch to display the next channel when in full screen preview.</p>
	<p>PASSWORD SETUP :</p> <p>Enable/disable full system password protection. This would prevent unauthorized user to stop video recording, change system settings and formatting the hard disk.</p>
	<p>AUDIO RECORD :</p> <p>Enable/disable audio recording. To record sound, make sure the microphone is connected to the unit.</p> <hr/> <p> The audio input device must be power supplied by external power. The DVR system doesn't supply the power to those devices.</p> <hr/>
	<p>AUDIO MUTE :</p> <p>Enable/disable to hear audio sound. To hear sound, make sure the unit is connected to a speaker.</p> <hr/>
	<p> If you want to hear the voice when you playback the recorded file on this DVR, please make sure that you have selected Audio Mute Off.</p> <hr/>
	<p>VIDEO SYSTEM:</p> <p>Display the current video system — PAL or NTSC</p>

OSD MENU	Description
SUBMENU PASSWORD CHANGE VIDEO ADJUSTMENT DATE 2006 / 12 / 11 TIME 17 : 54 : 50 AUTO RECORD ON AUTO SCAN ON PASSWORD SETUP NO AUDIO RECORD ON AUDIO MUTE OFF VIDEO SYSTEM NTSC TEMPERATURE SET BUZZER ON	TEMPERATURE SET: Set the DVR unit temperature type and high/low threshold limit.

TEMPERATURE SET	
TEMPERATURE TYPE	CENTIGRADE
HIGH THRESHOLD	050
LOW THRESHOLD	040
DVR HOT PROTECT	050
DVR COLD PROTECT	005

TEMPERATURE TYPE:

Temperature pattern display on front LED panel.

HIGH THRESHOLD:

Set a specific temperature limited for fan active. When the hard disk temperature is higher than limited temperature, the fan will be active. The default value is 50°C.

LOW THRESHOLD:

Set a specific temperature limited for fan stop. When the hard disk temperature is lower than limited temperature, the fan will be stop. The default value is 45°C.

DVR HOT PROTECT:

Set the temperature limit to shutdown hard disk when the DVR unit temperature is higher than (>) limited. The default value is 60°C.

DVR COLD PROTECT:

Set the temperature limit to stop recording when the DVR unit temperature is lower than (<) limited. The default value is 5°C.

BUZZER:

Enable/disable system buzzer sound. The default setting is **ON**.

Status	Sound
System Power ON	One long buzz sound
Video Loss	Continue long buzz sound
Fan stop/broken	Continue short buzz sound
Hard Disk is Full	Three Long buzz sound

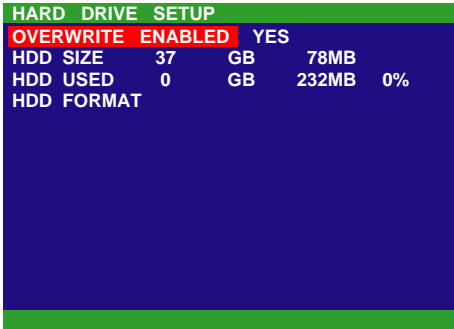

* HDD SIZE shows the total capacity of the hard disk.
 * HDD USED shows the amount of space that has been used.

OVERWRITE ENABLED :

Enable/disable replacing the earliest recorded file when the hard disk space runs out. By default, the HDD overwrite setting is enabled.

HDD FORMAT :

For security purpose, you may have to enter the password to format hard disk.

To format hard disk:

1. Use the and or and buttons to go up and down and select **HDD FORMAT**. Then press or (play).
2. In the **CHECK PASSWORD** screen, press , (play) or . Then use the and or and buttons to select the security combination number. Press , (play), or button again to make the selection. Or, use the number key buttons on the remote control to enter the password.
3. To move the selection to the left and right, use and buttons.

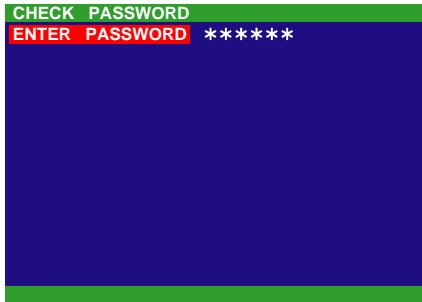

4. After entering the last number, the "PASSWORD CORRECT" appears, you are now authorized to format the hard disk.
5. It is done when the "HDD FORMAT COMPLETED" appears.

	Formatting the hard disk will permanently delete all the recorded files. The recorded files will be no longer for retrieving.
--	---





OSD MENU	Description
<pre> SENSOR SETUP SENSOR REC TIME 010 SEC ALARM OUT TIME 010 SEC CHANNEL - 1 NOT INSTALLED CHANNEL - 2 NOT INSTALLED CHANNEL - 3 NOT INSTALLED CHANNEL - 4 NOT INSTALLED </pre>	<p>SENSOR REC TIME : Set the amount of time (in second) to record when the sensor has been triggered.</p> <p>ALARM OUT TIME : Set the amount of time (in second) to continue sending the alarm once activated.</p> <p>CHANNEL 1~4 : Customize the initial state of the attached sensor. Refer to the table below to customize the sensor state.</p>

Condition	Description
NOT INSTALLED	Indicates that there is no sensor connected.
NORMAL OPEN	Indicates that the initial state of the sensor is normal open. Video recording initiate when there is a change in the sensor state.
NORMAL CLOSE	Indicates that the initial state of the sensor is normal close. Video recording initiate when there is a change in the sensor state.

<pre> MOTION SETUP MOTION CAMERA <input checked="" type="checkbox"/>1 <input checked="" type="checkbox"/>2 <input checked="" type="checkbox"/>3 <input checked="" type="checkbox"/>4 SENSITIVITY 5 MOTION RECORD TIME 010 SEC </pre>	<p>MOTION CAMERA : Enable/disable the channel number to detect motion.</p> <p>SENSITIVITY : Set the sensitivity level. The sensitivity is from high, 9~2 and low.</p> <p>MOTION RECORD TIME : Set the amount of time (in second) to record when a motion is detected.</p>
--	--

Chapter 4 Setup DVR in LED Mode





Besides OSD menu mode, user can setup DVR system in LED mode with remote control. To setup the DVR system, refer to the following function description.

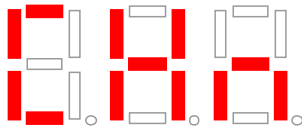
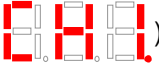
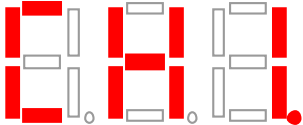
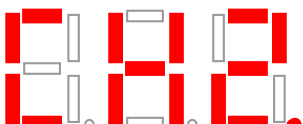
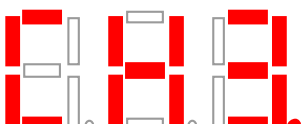
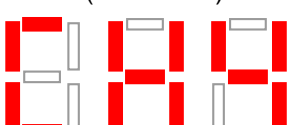

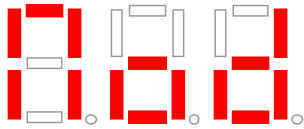
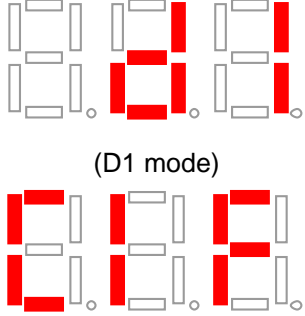
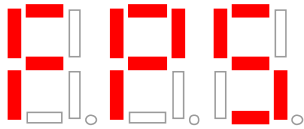
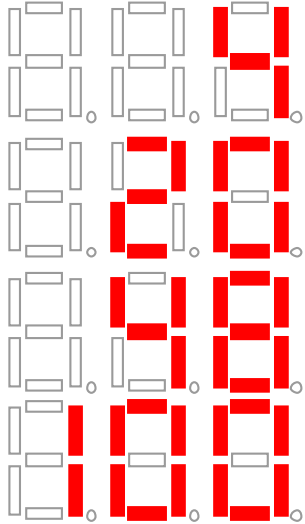
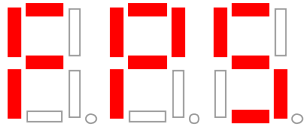
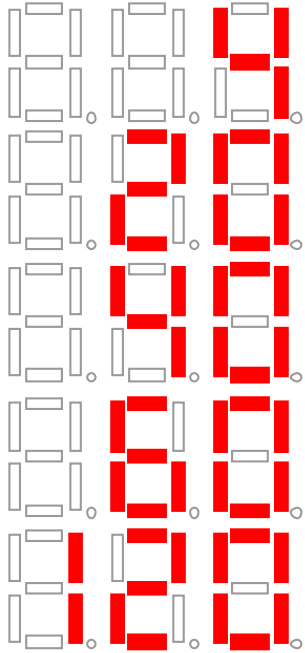
- Press  button to enter or exit setup function
- Use  and  button to select setup function
- Press  button to confirm selection.

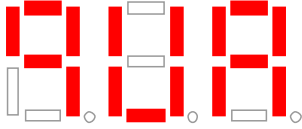

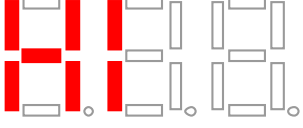
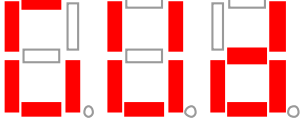
The following table list the symbols display in LED mode.

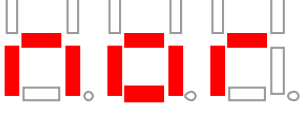
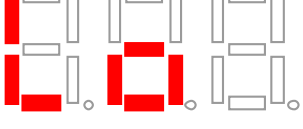
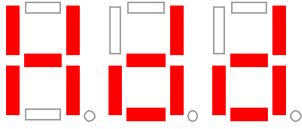
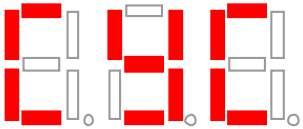
Function	Symbol of Title	Symbol of Selection
<p>Camera Select</p>	 <p>[NOTE] The recording function must be stopped when set up this function. The channel with dot sign means the channel is recording(ex. )</p>	 <p>(Channel 1)</p>  <p>(Channel 2)</p>  <p>(Channel 3)</p>  <p>(Channel 4)</p>

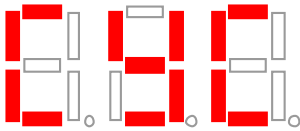
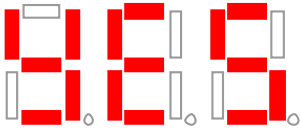
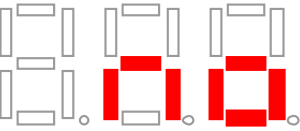
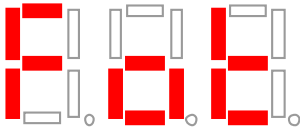
Function	Symbol of Title	Symbol of Selection
Record mode	 <p>[NOTE] The recording function must be stopped when set up this function.</p>	 <p>(D1 mode)</p> <p>(CIF mode)</p>
Record Framerate(PAL)		
Record Framerate(NTSC)		

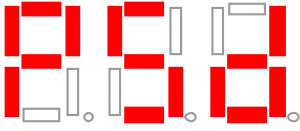
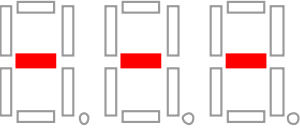
Function	Symbol of Title	Symbol of Selection
Video Quality	 <p data-bbox="619 781 715 813">[NOTE]</p> <p data-bbox="619 837 991 963">The recording function must be stopped when set up this function</p>	 <p data-bbox="1161 378 1241 409">(Best)</p>  <p data-bbox="1161 573 1241 604">(High)</p>  <p data-bbox="1161 768 1241 799">(Good)</p>  <p data-bbox="1137 963 1265 994">(Medium)</p>  <p data-bbox="1137 1155 1265 1187">(Normal)</p>  <p data-bbox="1161 1350 1241 1382">(Low)</p>
Hard Disk Setup		

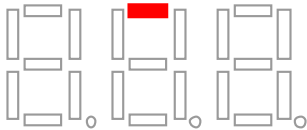
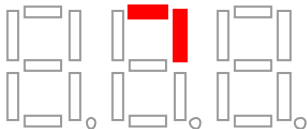
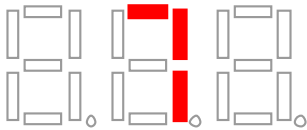
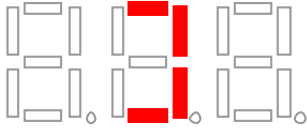
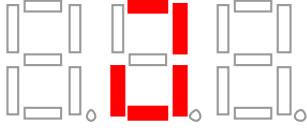
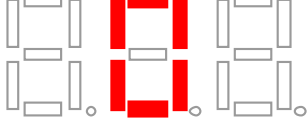
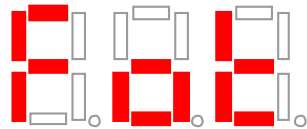
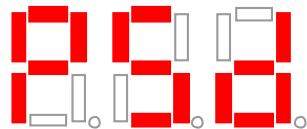

Function	Symbol of Title	Symbol of Selection
Hard Disk Overwrite		 <p>(Yes)</p>  <p>(No)</p>
Hard Disk Format/Password Check	 <p>[NOTE]</p> <ol style="list-style-type: none"> 1. The recording function must be stopped when set up this function 2. When  display, user can start to enter the password by using the number key on the remote control. 	 <p>(Password)</p>  <p>(To enter password)</p>

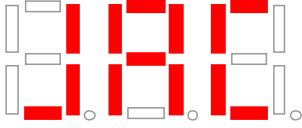
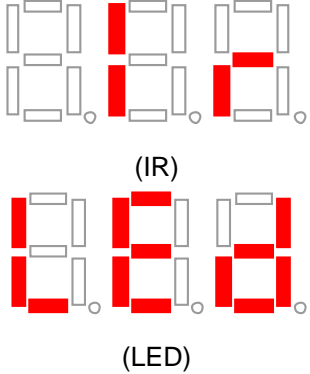
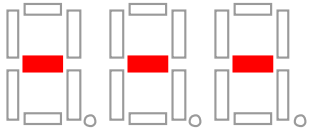
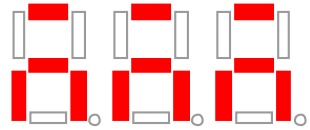
Function	Symbol of Title	Symbol of Selection
<p>Password Check</p>	<p>From 1st digit to 6th digit</p> <p>[NOTE]</p> <p>When user enter each digit of password, the LED panel will display each digit of indicating as right column shown. Using the number key buttons of remote control to enter the password. When all the password is entered press  or  (play) button to confirm.</p>	 <p>(Enter 1st digit)</p>  <p>(Enter 2nd digit)</p>  <p>(Enter 3rd digit)</p>  <p>(Enter 4th digit)</p>  <p>(Enter 5th digit)</p>  <p>(Enter 6th digit)</p>
<p>Password Pass (formatting) Password Fail</p>	<p>Symbol will flash several times</p>	 <p>(Formatting)</p>  <p>(Password failed and reenter password)</p>

Function	Symbol of Title	Symbol of Selection
Jack Setup		 <p>(IR)</p> <p>(LED)</p>
Warning indication	<p>Hard disk plug out</p> <p>Hard disk is full</p>	
	<p>Hard disk shutdown (higher than limited temperature)</p>	<p>LED display current temperature and flash</p>
	<p>Hard disk stop (lower than limited temperature)</p>	<p>LED display current temperature and flash</p>
Warning indication	FAN stop abnormally	

4.1 LED Panel Message Definition

While the DVR system is recording, LED panel will display general information of the system. When LED panel shows Dot point at right side flashes means the system is recording.

- Press  to display system temperature. To change temperature display type, please refer to [Chapter 3.1 of TEMPERATURE TYPE](#).
- Press  to display hard disk capacity.

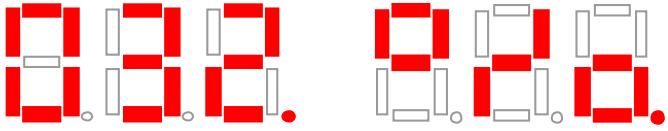
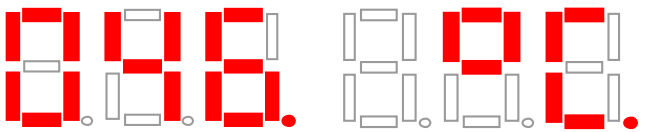
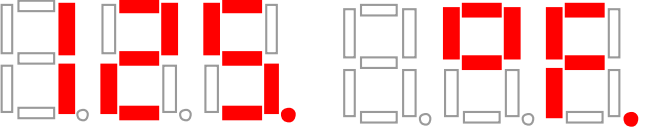
Description	Symbol
HDD capacity (percentage)	 <p>(32 %)</p>
Temperature (in Centigrade)	 <p>(46 °C)</p>
Temperature (in Fahrenheit)	 <p>(125 °F)</p>

Chapter 5 Using USB Playback Console

5.1 Recommended system requirements

- Pentium®4 2.4GHZ or above
- Windows®2000/ XP
- DDR 256 MB
- Graphic function (Must support DirectDraw)
- Audio card or built-in
- Speaker
- 1 available USB2.0 port

5.2 Installing the USB Playback Console

To install the Playback Console Application:

1. Place Installation CD into the CD-ROM drive. When the installation main screen appears, click **Install USB Playback Console** and then follow the on screen instructions



2. Select the language you prefer



3. Click **OK** to install the application
4. Click **“Exit”** to close the installation main screen. You may now connect the USB cable

- And then, the surveillance screen will display the USB backup message. Press **Select (Yes)** to accept USB Playback Console application to get the recorded video files from the hard disk. The DVR system will stop recording automatically.

5.3 Running the USB Playback Console

To run the application, click the **USB Playback Console** icon on the PC desktop.



Name	Function
(1)	Video playback screen

To select the video file for playing. The playback application supports *.dvr and *.avf file type.

- Open File



- **DVR Recorded File (HD):** To playback the recorded video from the hard disk which was recording video on the DVR system. (Also see [5.3.2](#))
- **Backup File(.dvr):** The file is backup and save in *.dvr file format. (Also see [5.3.3](#))

Name	Function
------	----------

Select the event you want to playback. The event list only available when user select to playback in **DVR Recorded File(HD)**.

(3) Event List

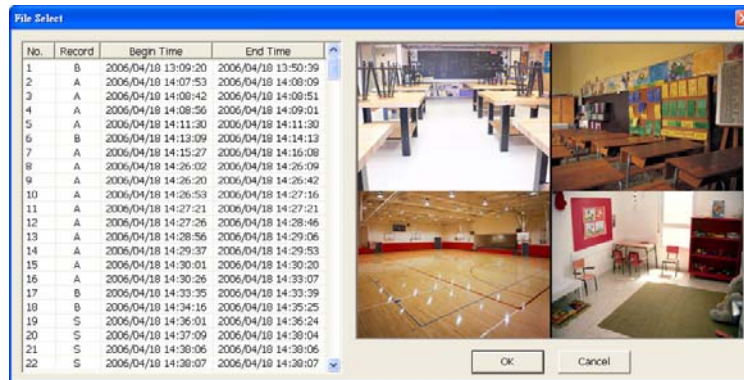

(4) Full screen

Use the entire area of the screen to only display the video. To return, press the right button of the mouse or **ESC** on the keyboard.

When you switch to full screen in multiple-channel mode, Left click to toggle to only display one of the video in the multiple-channel mode or all.

(5) Segment

Keep a portion of the recorded video (see also [5.3.1](#))

(6) Output

Save the segmented file in *.mpg or *.avi format (see also [5.3.1](#)).

(7) Snapshot

Capture and save the image either in *.jpg or *.bmp format

(8) Print

Print the image

(9) HDD Backup

To call out HDD Backup application. (See [Chapter 5.4](#))

(10) Video Enhancer

To call out i-Enhance application. (See [Chapter 7](#))

(11) Watermark

To call out ImageVerification application. (See [Chapter 6](#))

(12) Status bar

Display the recorded date, time and play speed.

(13) Progress bar

Show the progress of the file being played. You may move the bar to seek at any location of the track.

Begin: Move at the beginning of the recorded video file.

Previous: Go back to the previous frame by frame.

Slower: Play the recorded video file at the speed of 1/2x, 1/4x, or 1/8x.

(14) Playback Controller

Rewind: Wind back the recorded video file.

Pause: temporary stop playing the recorded video file.

Play: Play the recorded video file.

Faster: Play the recorded video file at the speed of 2x, 4x, or 8x.

Next: Go to the next frame by frame.

End: Go to the end of the recorded video file.

(15) Split Channel Mode

Select from different screen view to playback the recorded video file of the all channels or one channel on screen.

Exit/ Minimize the application or chose Cancel to go back to the application

(16) Exit

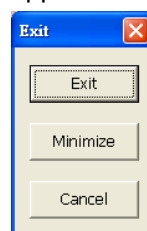

Name	Function
(17) Sound /Sound bar	Turn on and off the sound Increase and decrease the volume

5.3.1 To Cut and Save the Portion of the Recorded Video

1. Use the Playback Control buttons or drag the bar on the playback progress bar and pause on where you want to start the cut. Then, click **Segment** to set the begin mark.



2. Use the Playback Control buttons or drag the bar on the playback progress bar and pause on where you want to end the cut. Then, click **Segment** to set the end mark. To cancel segmentation, click **Segment** button again.



3. Click **Output** button to save the wanted portion.
4. In the **Save As** dialog box, locate on where user wants to save the file, type the filename, and select the video format.

5.3.2 Playback DVR Recorded File from Hard Disk

1. Click **Open File** button
2. Select **DVR Recorded File(HD)** and click **OK**.
3. Select the hard disk drive from **Select Disk** window and click **OK**.

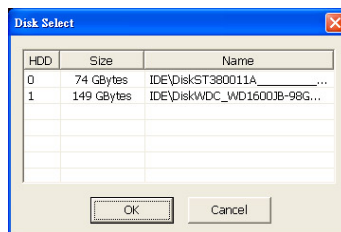

4. And then, the **Event List** window appears. Select the event that user wants to play and click **OK**.

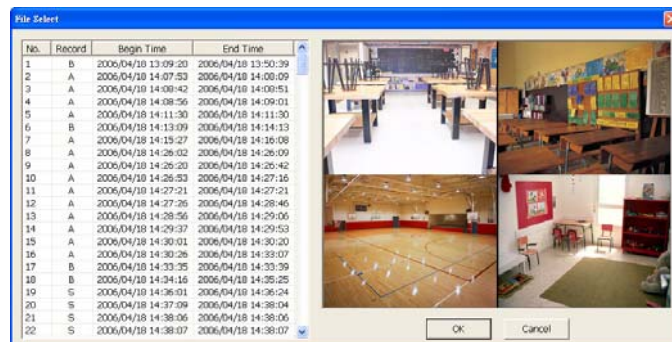

5.3.3 Playback Backup File(*.dvr)

1. Click Open File button.
2. Select **Backup File(*.dvr)** and click **OK**.
3. Locate the backup file folder and click **OK**.
4. And then, **Playback Date/Time** Selection window appears. Select the date and time and click **OK**.

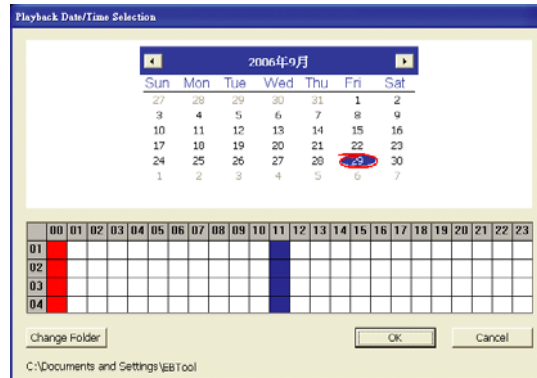

5.4 To Backup Recorded Video File

1. Click HDD backup button on the USB Playback Console interface.
2. OSD setup menu will appear on the surveillance monitor. Press **Select (Yes)** to accept HDD Backup application to get the recorded video file from the hard disk. And, EB1304 MOB will stop recording automatically.
3. And then, the **Select Disk** window will appear as below:

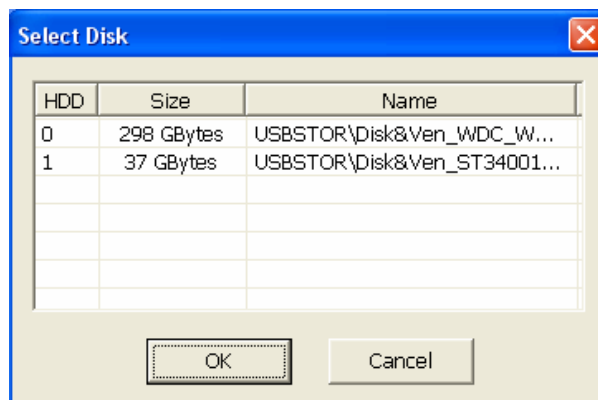

4. Select the hard disk drive from **Select Disk** windows. All available hard disk will list on the **Select Disk** windows with size and name
5. Select the hard disk drive and click **OK**
6. And then, the HDD Backup windows will appear as below:

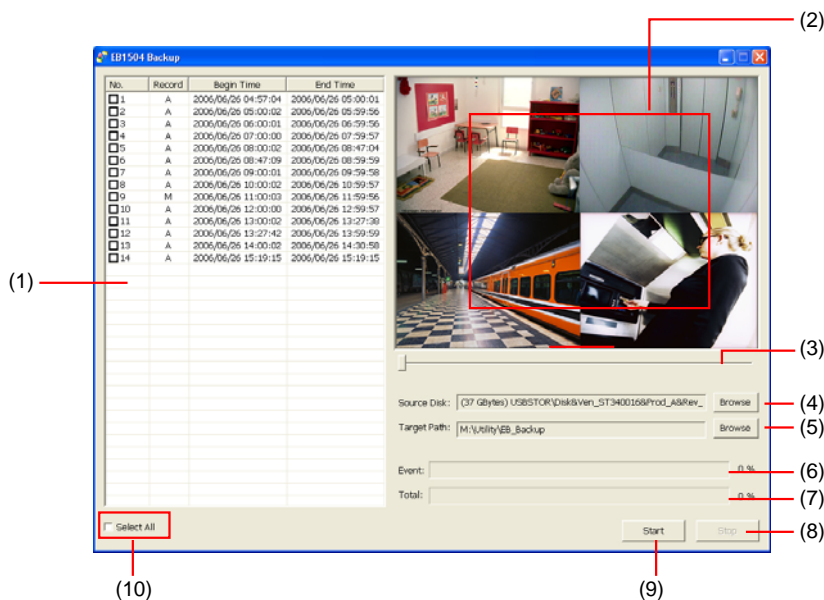

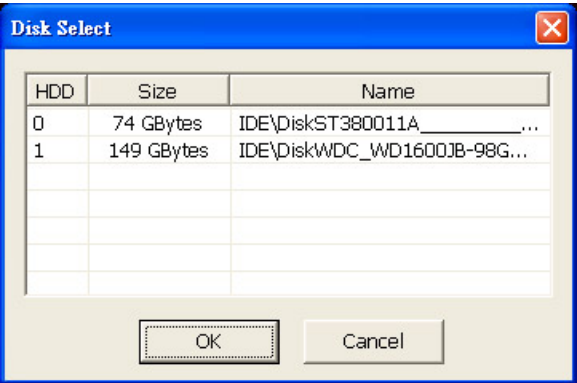
Name	Function
(1)	All recorded video events list No.: the list order number Record: the record type(see also Chapter 2.3.1) Begin Time: the beginning of record time End Time: the end of record time
(2)	Display first frame of each recorded video channels from 4 selected channels.
(3) Progress bar	Show the progress of the event being played. User may move the bar to seek at any location of the track
(4) Source Disk	To select the hard disk drive 
(5) Target Path	To locate on where user wants to save the file
(6) Event (%)	Display the backup progress rate of event in percentage
(7) Total (%)	Display the total backup progress rate in percentage
(8) Stop	Stop backup progress
(9) Start	Start backup progress
(10) Select All	Select all listed recorded video events

7. Select the event which user wants to backup or mark the **Select All** to select all listed recorded video events
8. Locate on where user wants to save the backup file
9. Click **Start** to process backup
10. To stop the backup progress, click **Stop**
11. To view backup file, please refer to [Chapter 5.3.2](#)

Chapter 6 Using ImageVerification

Image Verification is a watermark-checking program to identify the authenticity of a saved image (e.g. by snapshot). This program can only verify uncompressed bmp image files.

6.1 To Run the ImageVerification

1. To run the ImageVerification application, click the **Watermark** button on USB Playback Console main interface.
2. In the ImageVerification screen, click **Load Source Image** and locate the image source.
3. Click **Verify Image** to begin the process.
4. Check the result in the **Processed Image** screen. If the picture is unmodified, the image in the **Source Image** and **Processed Image** screen would be exactly the same. If the picture is being modified, a warning dialog box would prompt and the modified area is highlighted.

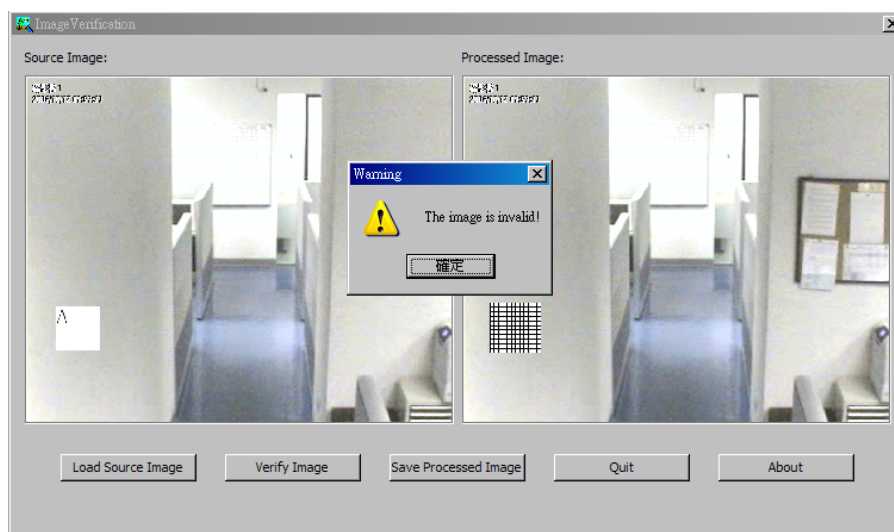

Chapter 7 Using i-Enhance

The bundled i-Enhance is a video editing tool and can only be used with *.dvr video file. It allows you to adjust the video picture quality, segment and save the selected portion of the video, zoom in and out the image, and print or save the screen shot. You can also save the setting and apply it on other files.

To run i-Enhance application, click **Video Enhancer** button on USB Playback Console interface.

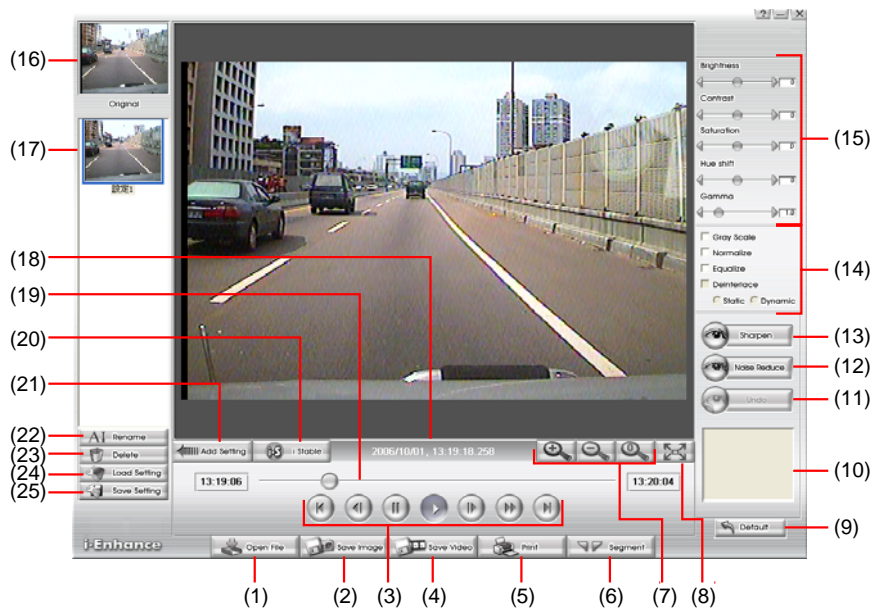

Name	Function
(1) Open File	Access *.dvr video file.
(2) Save Image	Capture and save the screen shot in *.bmp format.
(3) Playback Control Buttons	Begin: Move at the beginning of the video file. Previous: Go back to the previous frame. Rewind: Wind back the video file. Pause: Temporary stop playing the video file. Play: Play the video file. Faster: Play the video file at the speed of 2x, 4x, or 8x. Next: Go to the next frame. End: Go to the end of the video file.
(4) Save Video	Save the edited or segmented video in *.avi format.
(5) Print	Print the screen shot.
(6) Segment	Mark the beginning and the end of the selected portion of the video. Two triangle marks will appear on the slider. To cancel video segmentation, click this button again.
(7) Zoom Buttons	Enlarge, reduce, and set the image back to normal size.
(8) Full Screen	Use the entire screen to only display the video.
(9) Default	Set the video back to original state and delete all the changes in the history box.

Name	Function
(10) History Box	List all the actions.
(11) Undo	Delete the last action.
(12) Noise Reduce	Adjust the softness and repair the damaged colours.
(13) Sharpness	Improve the overall image by enhancing edges. This gives the image more depth.
(14) Effects	Gray Scale: convert the image into black and white (monochrome). Normalize: adjust the brightness intensity. Equalize: automatically adjust the images that are too dark. De-interlace: smooth out the overlying frames. Static: de-interlace for motionless scene. Dynamic: de-interlace for moving scene.
(15) Picture Adjustment	Adjust the Brightness, Contrast, Saturation, Hue and Gamma.
(16) Original Screen	Display the original state of the image.
(17) Temporary Setting Block	Display the sample settings. Click the sample to apply the setting on the current video.
(18) Status Bar	Display the date, and time of the video.
(19) Progress Bar	Show the progress of the file being played. You may move the bar to seek at any location of the track.
(20) i-Stable	To reduce the jolt in the recorded video.(also see Chapter 7.1)
(21) Add Setting	Include the new setting to the temporary setting block.
(22) Rename	Change the name of the selected setting in the temporary setting block.
(23) Delete	Permanently remove the selected setting in the temporary setting block.
(24) Load Setting	Call the saved settings.
(25) Save Setting	Store the settings in the temporary setting block.

7.1 To Use i-Stable

The i-Stable function can reduce the jolt in the recorded video.

1. Click **Open File** button and select the recorded video.
2. And then, click **i-Stable** button.
3. i-Stable windows will show up.
4. Select the **smoothness** level – 1(Low), 2, 3, 4, and 5(High). The default value is 3.
5. Click Play button, and then i-Stable function will start to initial the recorded video.
6. When the initialize is done, user will see the original and stabilized recorded video play in two windows.

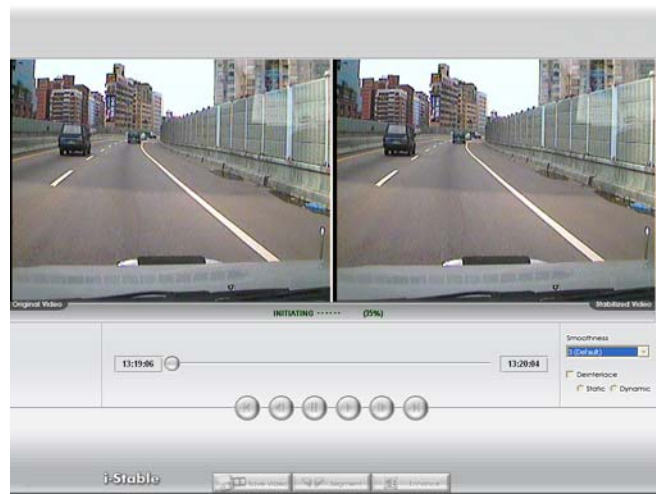

Warranty Notice

LIMITED WARRANTY

AVerMedia TECHNOLOGIES, Inc. warrants this product to be free of defects resulting from faulty manufacture or components under the following terms:

WARRANTY LENGTH

Labor is warranted for (1) one year from the date of purchase.

Parts are warranted for (1) one year from the date of purchase.

Replacement products will be warranted for the remainder of the one year warranty period or (30) thirty days, whichever is longer.

WHO IS PROTECTED

This warranty is enforceable only by the first consumer purchaser.

WHAT IS AND IS NOT COVERED

Except as specified below, this warranty covers all defects resulting from faulty manufacturing of this product. The following are not covered by the warranty.

1. Any product on which the serial number has been defaced, modified, or removed.
2. Damage, deterioration, or malfunction resulting from :
 - Accident, abuse, misuse, neglect, fire, water, lightning, or other acts of nature, commercial or industrial use, unauthorized product modification, or failure to follow instructions included with the product.
 - Misapplication of service by someone other than the manufacturer's representative.
 - Any shipment damages. (Claims must be made with carrier.)
 - Any other cause which does not relate to a product defect.
3. Cartons, cases, batteries, cabinets, tapes, or accessories used with product.
4. AVerMedia does not warrant that this product will meet your requirements; it is your responsibility to determine the suitability of this product for your purpose.

WHAT WE WILL AND WILL NOT PAY FOR

We will pay labor and material expenses for covered items. However, we will not pay for the following :

1. Removal or installation charges.
2. Shipping charges.
3. Any incidental charges.

EXCLUSION OF DAMAGES

THE MANUFACTURER'S SOLE OBLIGATION AND LIABILITY UNDER THIS WARRANTY IS LIMITED TO THE REPAIR OR REPLACEMENT OF A DEFECTIVE PRODUCT AT OUR OPTION. THE MANUFACTURER SHALL NOT, IN ANY EVENT, BE LIABLE TO THE PURCHASER OR ANY THIRD PARTY FOR ANY INCIDENTAL OR CONSEQUENTIAL DAMAGE (INCLUDING, BUT NOT LIMITED TO, DAMAGES RESULTING FROM INTERRUPTION OF SERVICE AND LOSS OF BUSINESS) OR LIABILITY IN TORT RELATING TO THIS PRODUCT OR RESULTING FROM ITS USE OR POSSESSION.

LIMITATIONS OF IMPLIED WARRANTIES

There are no other oral or written warranties, expressed or implied, including but not limited to those of merchantability or fitness for a particular purpose. Any implied warranties are limited in duration to one year from the date of purchase.

STATE LAW AND YOUR WARRANTY

This warranty gives you specific legal rights, and you may also have other rights granted under state law. These rights vary from state to state.

CONTACT INFORMATION

<http://www.avermedia.com>
<http://www.averdigi.com>